

The CLS-Class.

Coupé and Shooting Brake.



Mercedes-Benz

The new-generation CLS. Form. Illuminated.

How many times does one meet an exceptional personality in one's lifetime? If you wish, it can be every day – and on every drive. The new-generation CLS captivates with its pioneering LED light system, its efficient, powerful engines, with an innovation in its transmission design and lots more. Surrounded by a design of precious rarity value. Discover the perfect symbiosis of light and form.

SOURCES. ILLUMINATED.



Experience the new-generation CLS in glorious HD. With the Mercedes-Benz brochure app for the iPad® and with the Digital Owner's Manual from "Mercedes-Benz Guides" for the iPhone®. Both apps feature a host of films and additional content and are available free of charge from the iTunes Store®.

Spectrum. Illuminated.

2 | CLS 500 Coupé diamond silver metallic

AMG Line, AMG multi-spoke light-alloy wheels, designo semi-aniline leather upholstery in classic red/black, black piano lacquer trim

10 | CLS 63 AMG S-Model 4MATIC Coupé designo diamond white bright

AMG Exterior Carbon-Fibre package I + II, AMG cross-spoke forged wheels, Exclusive package, Exclusive PASSION leather upholstery in black with light contrasting topstitching, AMG carbon-fibre/black piano lacquer trim

16 | CLS 350 BlueTec Shooting Brake cavansite blue metallic

Exterior Sports package, 5-twin-spoke light-alloy wheels, Exclusive package, Exclusive PASSION leather upholstery in saddle brown/black, high-gloss brown linestructure lime wood trim

24 | CLS 63 AMG S-Model 4MATIC Shooting Brake palladium silver metallic

AMG Night package, AMG 10-spoke light-alloy wheels, Exclusive package, Exclusive PASSION leather upholstery in black with light contrasting topstitching, AMG carbon-fibre/black piano lacquer trim

Strengths. Illuminated.

- 32** | Engines
- 34** | 9G-TRONIC automatic transmission
- 35** | AIRMATIC air suspension system
- 36** | MULTIBEAM LED light system
- 38** | Driving Assistance package Plus
- 41** | Integral safety concept
- 42** | Mercedes connect me
- 46** | CLS 63 AMG
- 48** | AMG Night package
- 49** | AMG Exterior Carbon-Fibre package
- 50** | CLS 63 AMG S-Model 4MATIC
- 53** | AMG Performance Studio
- 54** | Equipment and packages
- 60** | designo
- 61** | Genuine Accessories
- 62** | Wheels
- 64** | Services
- 66** | Technical data
- 69** | Upholstery and paintwork

The illustrations may show accessories and optional extras which are not part of the standard specification.



Coupés have always had that certain special something about them. But the Mercedes-Benz engineers wanted even more: a Coupé with four doors and comfortable rear seats. The unveiling of the original CLS marked the birth of a design icon, surpassed only by the new-generation CLS. With the nine-speed 9G-TRONIC automatic transmission for even more efficiency and dynamism (for selected models). The optionally available MULTIBEAM LED light system. And lines that are just made for a grand entrance.

Outshines everything.





MULTIBEAM LED

LEDs are very much at the forefront when it comes to the future of lighting technology – due to their stronger luminosity and the rare semiconductor crystals. With their help, the luminous efficiency of LEDs can exceed that of conventional bulbs several times over. If the optionally available MULTIBEAM LED light system is ordered, each headlamp is equipped with 36 LEDs, of which some 24 can be con-

trolled individually. To this end, a camera positioned behind the windscreen surveys the current traffic conditions. Based on the information they receive, four control units calculate the ideal light pattern a hundred times per second and illuminate the LEDs precisely where light is needed almost instantaneously.

Perception-altering light.





Appears in top form.







At the airport you are ushered into the business lounge. On the train you can prepare for your next meeting whilst travelling at high speed. But the most pleasurable trips of all are at the wheel of the CLS Coupé. The extensive range of standard equipment and appointments, including a 20.3 cm display, the choice materials and a wealth of individualisation options such as the new designo interior colour schemes create special surroundings for special moments.



Puts the rest of the world in the shade in 3.6 seconds.

When the CLS 63 AMG S-Model 4MATIC Coupé with 430 kW (585 hp) and 800 Nm is straining at the leash, there's no holding back your endorphins. The dynamically configured AMG Performance 4MATIC all-wheel drive ensures that the road also gets to feel the concentrated power of the AMG 5.5-litre V8 biturbo engine. Other drivers therefore only get a fleeting glimpse of the AMG front apron in striking A-wing design and the rear end dominated by the diffuser and featuring two chromed twin tailpipe trim elements.







Speed. Illuminated.

More comet than coupé.





Who wouldn't want to be cosseted by these seats? Refined with light contrasting topstitching in conjunction with optionally available black Exclusive PASSION leather and crowned by "AMG" emblems in the front head restraints, they provide perfect support on fast bends. Step over the white illuminated AMG door sill panels – and experience the sheer excitement of AMG the moment you first set eyes on the AMG instrument cluster, including 11.4 cm TFT multifunction display, RACETIMER and AMG start-up display.

Aura. Appeal.

Certain personalities exude a special aura. It's hard to describe, but you feel it straight away. A phenomenon – just like the new-generation CLS Shooting Brake. With all the cosseting comfort and exciting dynamism you could wish for. Highly impressive in stature. And with a design idiom that attracts the right kind of attention.





The calm and the storm:
the 9G-TRONIC.





9G-TRONIC

When Carl Benz invented the automobile, he used a flat belt to transfer the engine power. For starting off, this belt was moved from an idler pulley to a fixed pulley. This design gave the original version of the patent motor car precisely one gear – and laid the foundations for every Mercedes-Benz transmission innovation since. Such as the 9G-TRONIC nine-speed automatic transmission (availability depending on engine), which performs highly

complex gear changes using just four simple planetary gear groups and six shift components – allowing an extremely compact design. Lower rpm levels mean that the 9G-TRONIC also reduces fuel consumption. All that increases (and keeps on increasing) is the driving enjoyment – thanks to faster gear changes with smaller engine speed increments.

Freedom to do more.

Do you like expanding your horizons? You don't have to look too far to keep on discovering new things in the CLS Shooting Brake. Although you almost could in its vast open-design interior. A third seat in the rear allows up to five people to enjoy the view – not least the high-grade interior appointments in the new, optionally available saddle brown/black colour combination.





A close-up photograph of a car seat upholstered in brown perforated leather. The seat features a complex stitching pattern with vertical and horizontal lines, creating a grid-like structure. The perforations are small and evenly spaced. The lighting is soft, highlighting the texture of the leather and the contours of the seat. In the background, another similar seat is partially visible, and the interior of the car is dimly lit.

You could be the one sitting in the ergonomically designed seats of the CLS soon. They even come with the option of exclusive semi-aniline leather upholstery. The outstanding build quality increases the anticipation – as do the optional climatized seats. Likewise available as an option, the high-gloss brown linestructure lime wood trim emphasises this unique ambience.



Even the earth feels attracted to it.

The CLS 63 AMG S-Model 4MATIC Shooting Brake would have turned the world of Isaac Newton well and truly on its head as its gravitational attraction knows almost no bounds. The dynamically configured AMG Performance 4MATIC all-wheel drive with a rear-biased torque split of 33 : 67 combines optimum traction, hallmark AMG driving dynamics and maximum driving enjoyment. Depending on the selected ESP® stage, individual brake actuations on each wheel and active engine management reduce understeer. The result is that the CLS takes every bend well and truly in its stride.









AMG. High performance
inside and out.



Inner force.

The cockpit of the CLS 63 AMG S-Model 4MATIC Shooting Brake is a blend of systematic functionality and exclusive appointments. Finely matched with optionally available AMG carbon-fibre/black piano lacquer trim. With a new AMG performance steering wheel, including “AMG” lettering and alpaca grey “12 o’clock” marking, plus an instrument cluster with a speed dial that now goes all the way up to 320 km/h.

DESIGNO WOODEN LOAD COMPARTMENT FLOOR

A material usually reserved for the sun decks of large yachts is available as an option to add a further touch of refinement to the load compartment in the CLS Shooting Brake: American cherry wood with black inlay work in dark fumed oak. Using a sophisticated production process, choice veneer sheets are glued and pressed together by hand under high pressure in five layers to achieve high dimensional stability. Finally, the surfaces are painstakingly sanded to a smooth finish and waterproofed before being varnished. All of which emphasises the natural beauty of the robust fine wood.

What makes a car a Mercedes?

Deep-rooted traditions: in our case, it is innovative traditions that run deep. We have continually gone down previously uncharted avenues. Milestone by milestone. These ventures spawned the first vehicle with a crumple zone, the first ABS, the first diesel car. The first automobile. But rather than dwelling on the past, let us look to the future.

Mercedes-Benz Intelligent Drive – on the road to accident-free driving. We develop intelligent assistance systems which actively support the driver and noticeably relieve the driver's workload. They monitor and analyse the vehicle's surroundings and handling – and warn the driver if they identify any critical situations. When necessary, some of the systems are able to intervene to take corrective action. Potential dangers are identified earlier than ever – and ever more frequently avoided as a result. Discover the fascinating world of Mercedes-Benz Intelligent Drive at www.mercedes-benz-intelligent-drive.com

BlueEFFICIENCY – our vision of emission-free driving. Sustainability is a big word to which we lend real meaning in all that we do, down to the smallest details. From minimising the environmental impact of our production operations to alternative drive concepts.



Welcome to a world that revolves around you. We focus on people. This is the standard we adhered to when we developed a new platform for your personal contact with Mercedes-Benz. With individual services made for you. "connect me" links the vehicle with your world, with everything that is important to you. "move me" offers new mobility solutions. And with "inspire me" we give you an exclusive look ahead at the future of mobility. Your access to an exciting world: www.mercedes.me

As you can see, we have major goals in our sights. And what could be better than seeing these aims achieved whilst on a long drive in a Mercedes?

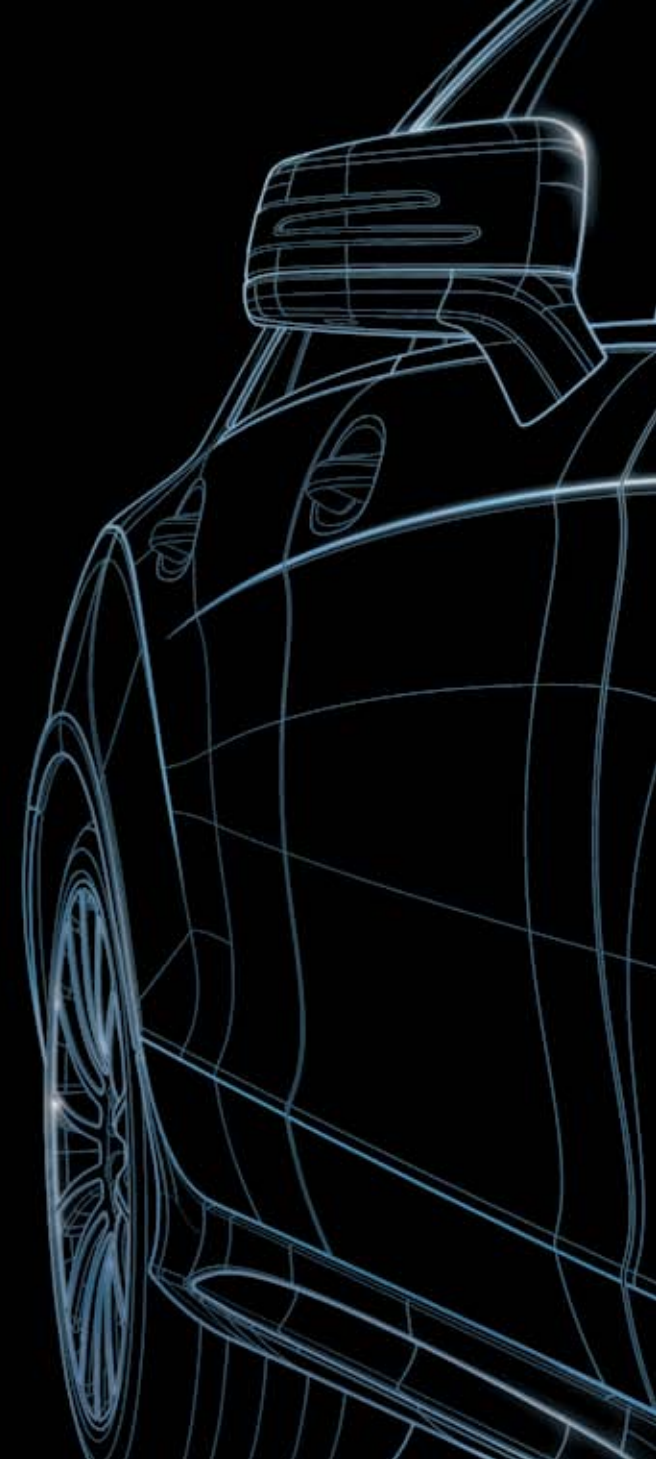

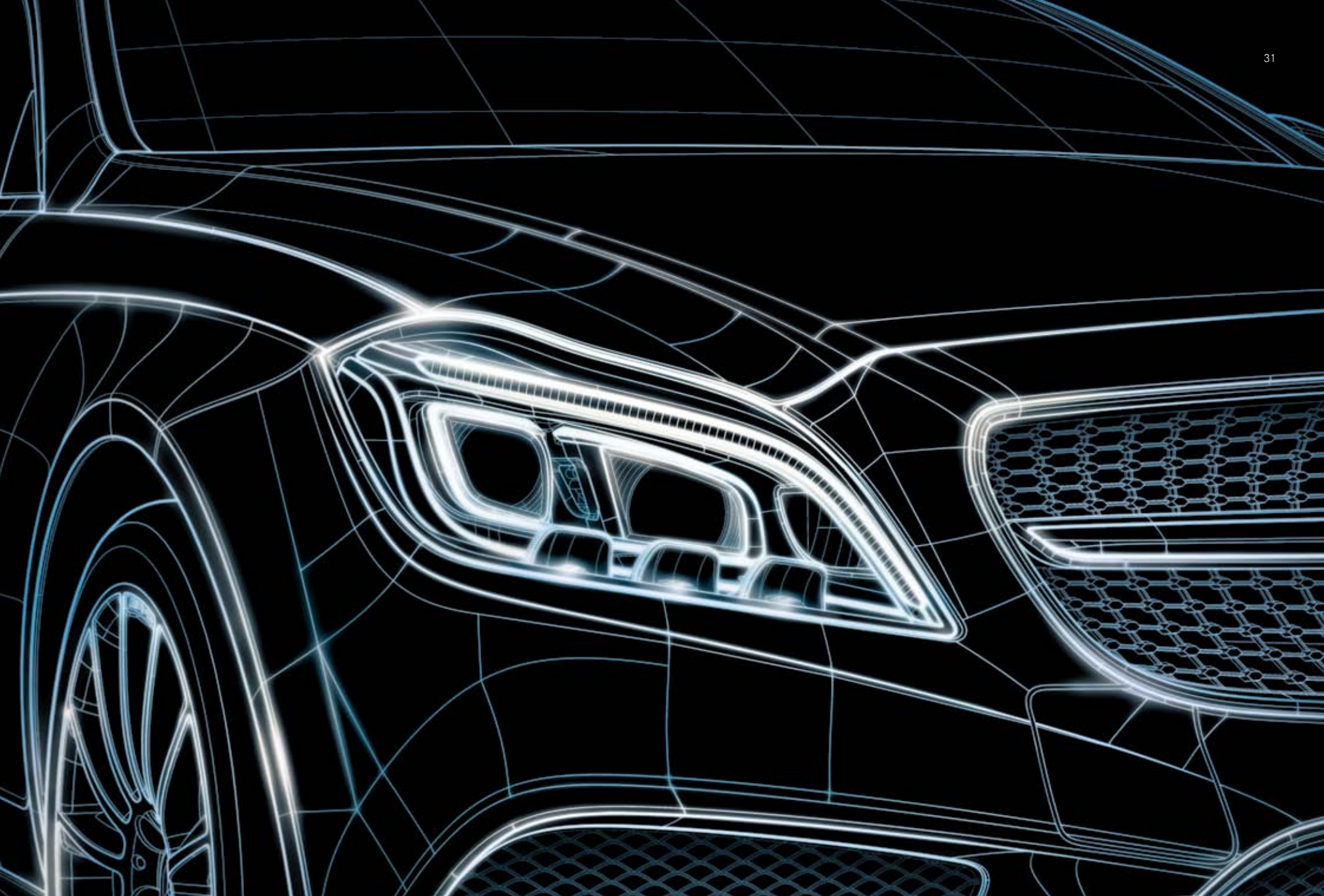

Hungry rather than thirsty: the drive technologies.

Efficiency and dynamism have long gone hand in hand at Mercedes-Benz. The new **CLS 400** with V6 petrol engine, twin turbochargers and a displacement of 3.5 litres succeeds in combining low fuel consumption with a further substantial increase in output. In particular, the engine speed range across which the maximum torque is available ensures high-level driving dynamics with relatively low rpm.

Clean power: clean combustion.

Our diesel engines are also more efficient than ever. Thanks to BlueTEC – the Mercedes-Benz-developed modular concept for effective reduction of fuel consumption and emissions. And for compliance with the stringent Euro 6 emissions standard. The CLS BlueTEC models feature an oxidising catalytic converter and particulate filter with a particularly long-lived NO_x storage-type catalytic con-

verter. These are combined with an additional SCR catalytic converter (SCR = Selective Catalytic Reduction). The increase in peak pressure and compression ratio leads to improved combustion and a lower particulate mass. SCR exhaust gas aftertreatment converts nitrogen oxides into harmless nitrogen and water vapour, reducing environmentally harmful emissions to a minimum.

The perfect way to plant the power on the road: 4MATIC all-wheel drive.

Whether combined with a petrol or diesel engine, the optionally available **4MATIC all-wheel drive** sends the drive power to precisely where it can be best transferred to the road. With a fixed rear-biased torque split of 45% : 55%, it provides an ideal blend of directional stability, dynamism and efficiency even when there is little grip.

THE ENGINE RANGE

Diesel:

CLS 220 BlueTEC with an output of 125 kW (170 hp) and 400 Nm of torque

CLS 250 BlueTEC and CLS 250 BlueTEC 4MATIC with an output of 150 kW (204 hp) and 500 Nm of torque

CLS 350 BlueTEC with an output of 190 kW (258 hp) and 620 Nm of torque

CLS 350 BlueTEC 4MATIC with an output of 185 kW (252 hp) and 620 Nm of torque

Petrol:

CLS 400 and CLS 400 4MATIC with an output of 245 kW (333 hp) and 480 Nm of torque

CLS 500 and CLS 500 4MATIC with an output of 300 kW (408 hp) and 600 Nm of torque

CLS 63 AMG (Coupé only) and CLS 63 AMG 4MATIC with an output of 410 kW (557 hp) and 720 Nm of torque

CLS 63 AMG S-Model 4MATIC with an output of 430 kW (585 hp) and 800 Nm of torque

↘ FIND OUT MORE

Detailed technical data for the CLS can be found on page 66/67.

An engine so powerful it deserves its own chapter: details of the new-generation CLS 63 AMG can be found starting on page 46.

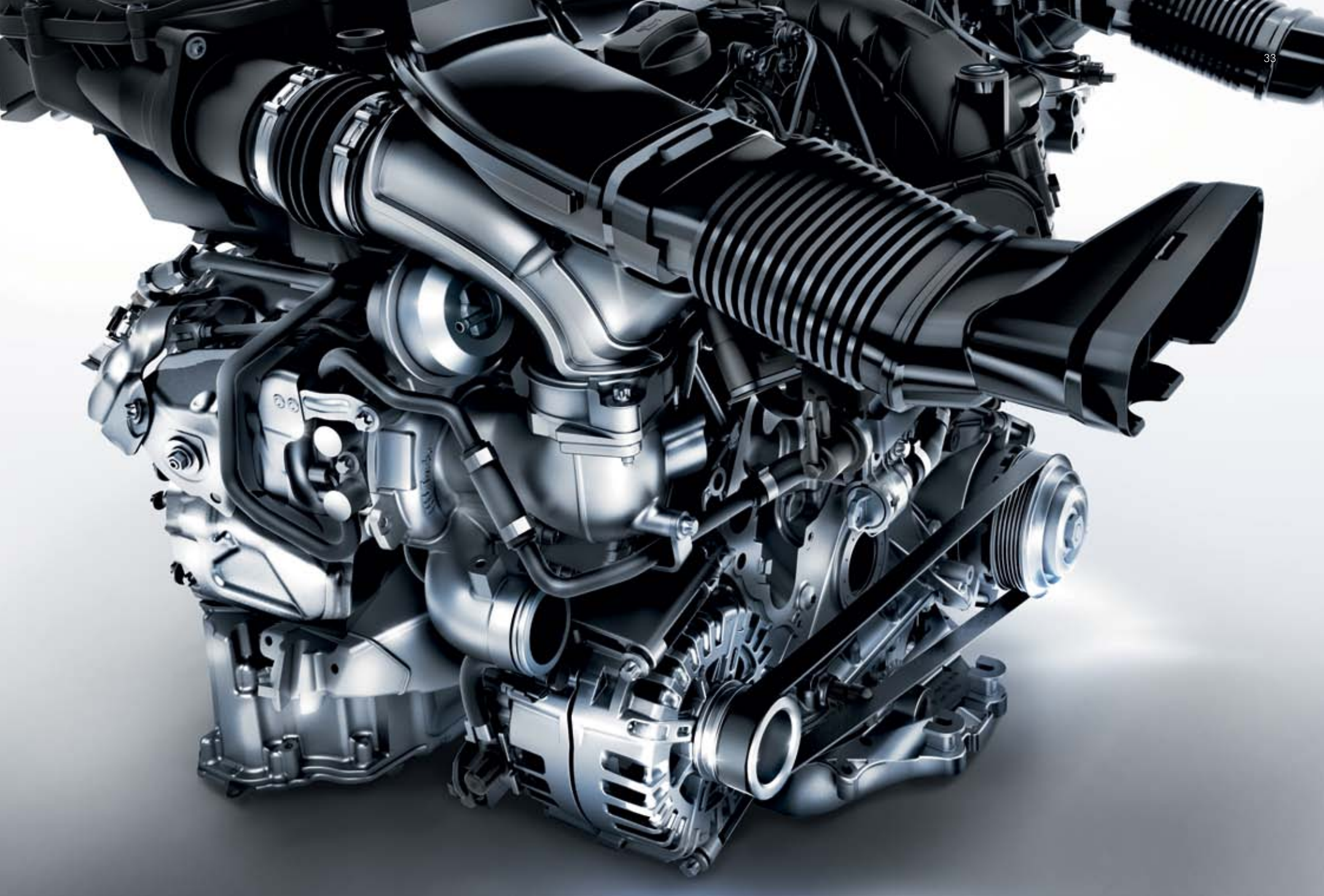

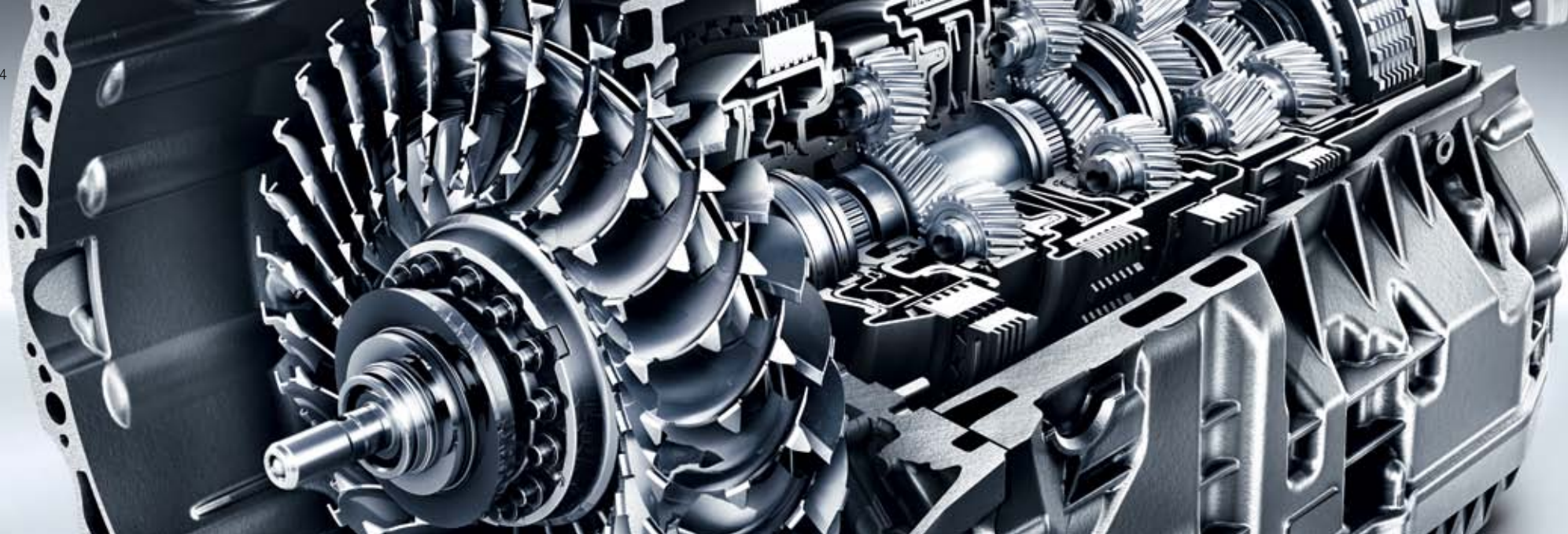

Small speed increments, giant leaps forward: the 9G-TRONIC.

The **9G-TRONIC** is the world's first nine-speed automatic transmission with hydrodynamic torque converter in the premium class. Despite its two additional gears and the maximum transmissible torque of 1000 Nm, the 9G-TRONIC remains very light. The converter housing is made of aluminium, while the transmission housing with a weight-optimised plastic oil sump is constructed using an even lighter magnesium alloy.

The high efficiency helps to reduce fuel consumption. The larger ratio range allows a reduction in engine speed, resulting in enhanced ride comfort and a further reduction in the noise level. At the same time, the 9G-TRONIC impresses with its smooth, barely perceptible gear shifting. This enhanced spontaneity and agility can likewise be enjoyed in manual mode – with the **DIRECT SELECT steering wheel gearshift paddles**. The ECO start/stop function reduces fuel consumption and is available in conjunction with the 9G-TRONIC or the 7G-TRONIC PLUS.

7G-TRONIC PLUS TRANSMISSION

Depending on the selected model, the CLS can also be equipped with the 7G-TRONIC PLUS. Thanks to a torsional damper, it allows exceptionally comfortable and fuel-saving driving at low engine speeds. In addition, optimum vibration damping in the transmission ensures even more rapid response to accelerator commands.

PLEASE NOTE:

The availability of the two transmission variants is dependent on the selected engine model. Further information can be found in the price list, in the online configurator or from your Mercedes-Benz dealership. We will be pleased to advise you.



Smooths the way: the AIRMATIC air suspension system.

With the optionally available **AIRMATIC** air suspension system (standard equipment for the CLS 500/CLS 500 4MATIC), road unevenness practically dissolves into thin air. In combination with variable damper control, it ensures ride comfort and dynamic handling at a very high level. The damping at each wheel is adapted to the current driving situation, and can be set for more comfortable or sporty characteristics as required. Hardening of the spring rate, for example on bends and when braking, effectively reduces rolling and pitching movements. Thanks to level control all-round, the vehicle maintains a constant level irrespective of the payload. The suspension level can be raised by 30 mm to increase ground clearance. At high speeds the suspension is automatically lowered by up to 20 mm, helping to reduce aerodynamic drag and improve handling stability.

FOR THE DIRECT ROUTE

The **DIRECT CONTROL suspension** with selective damping system, tuned for optimum comfort, guarantees top-level comfort on long journeys in the 4- and 6-cylinder models. The vibration dampers automatically adjust to the driving conditions, thereby improving the damping effect and stability of the vehicle. Thanks to lowering of the body by 15 mm plus the tauter suspension and damping, the **DIRECT CONTROL sports suspension** in conjunction with the Exterior Sports package or the AMG line allows a more dynamic driving style.

The **Direct-Steer system** adds to the comfort of speed-sensitive power steering with a variable steering ratio dependent on the steering wheel angle. For more agile vehicle response on winding routes and increased directional stability when driving straight ahead.



24 new highlights: MULTIBEAM LED light system.

Mercedes-Benz Intelligent Drive stands for the comprehensive networking of all the sophisticated technologies that assist and support the driver. One example of this is the optionally available **MULTIBEAM LED** light system, which can improve visibility in a wide range of conditions. In each headlamp, 24 out of a total of 36 LEDs are controlled individually. Using data supplied by a camera on the windscreen, specially developed control units calculate the ideal light distribution for every driving situation. This enables the headlamps to react extremely quickly to the current traffic situation. On detecting that the vehicle is on a motorway, MULTIBEAM LED additionally increases the range and light output – without dazzling oncoming traffic.

The active light function with preview function (available in conjunction with the Lane Tracking package or Driving Assistance package Plus) illuminates the bend before the steering wheel is turned and prior to leaving the bend again. In particularly tight bends, when turning off and at roundabouts, the cornering light function with navigation-assisted roundabout function (available in conjunction with COMAND Online) minimises the risk of the driver overlooking something. And should fog impair visibility, the enhanced fog light function makes it easier for the driver to keep their bearings.

VIEW EVERYTHING IN A NEW LIGHT

Even the standard **LED High Performance headlamps** enhance safety at night. LED technology illuminates the road ahead better than conventional headlamps – and it uses less energy.

The **LED daytime running lamps** integrated in the headlamps and the **darkened LED tail lamps** with adaptive beam intensity have an unmistakable look even when visibility is good.

The **new headlamp design** in the optional MULTIBEAM LED light system creates a distinctive, unmistakable look.

Adaptive Highbeam Assist Plus (part of MULTIBEAM LED) allows main beam to be left on at all times without dazzling other road users. As a result the best possible headlamp range is always available to the driver. The function is active from a speed of 30 km/h on unlit roads.

When the car is unlocked, the **exterior welcome light** (part of MULTIBEAM LED) greets the driver with an extraordinary light show. Initially the headlamps flash yellow, then a blue LED is activated to highlight the “Mercedes-Benz” lettering, after which this transforms into the white locator lighting.

↘ **FIND OUT MORE**

For all the information on Mercedes-Benz Intelligent Drive for PC, tablet or smartphone, visit www.mercedes-benz-intelligent-drive.com

You can find out all you need to know about the innovative light system for the CLS by downloading the “CLS Light” app for your iPad® – exclusively available from the iTunes Store®.

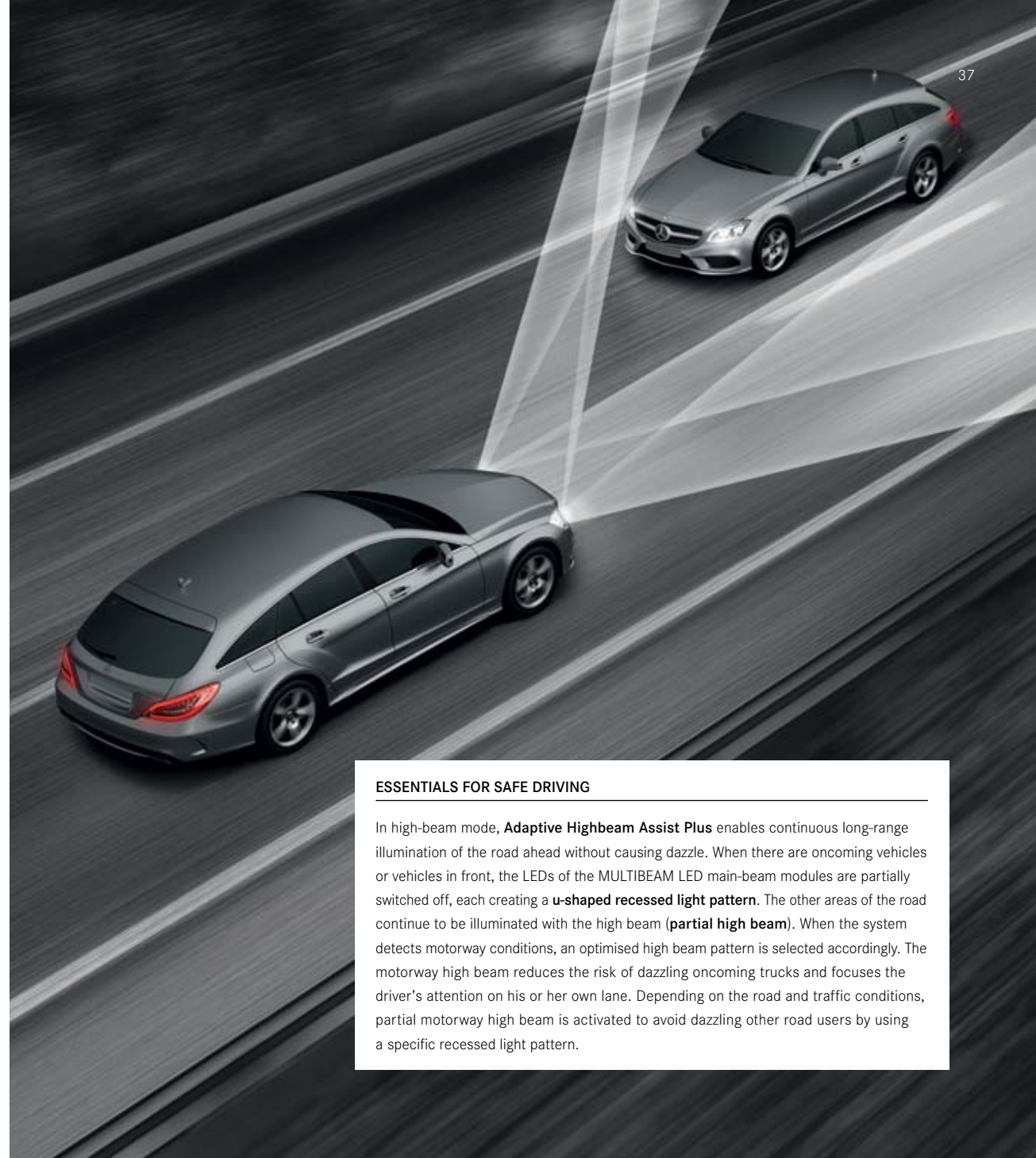

ESSENTIALS FOR SAFE DRIVING

In high-beam mode, **Adaptive Highbeam Assist Plus** enables continuous long-range illumination of the road ahead without causing dazzle. When there are oncoming vehicles or vehicles in front, the LEDs of the MULTIBEAM LED main-beam modules are partially switched off, each creating a **u-shaped recessed light pattern**. The other areas of the road continue to be illuminated with the high beam (**partial high beam**). When the system detects motorway conditions, an optimised high beam pattern is selected accordingly. The motorway high beam reduces the risk of dazzling oncoming trucks and focuses the driver’s attention on his or her own lane. Depending on the road and traffic conditions, partial motorway high beam is activated to avoid dazzling other road users by using a specific recessed light pattern.

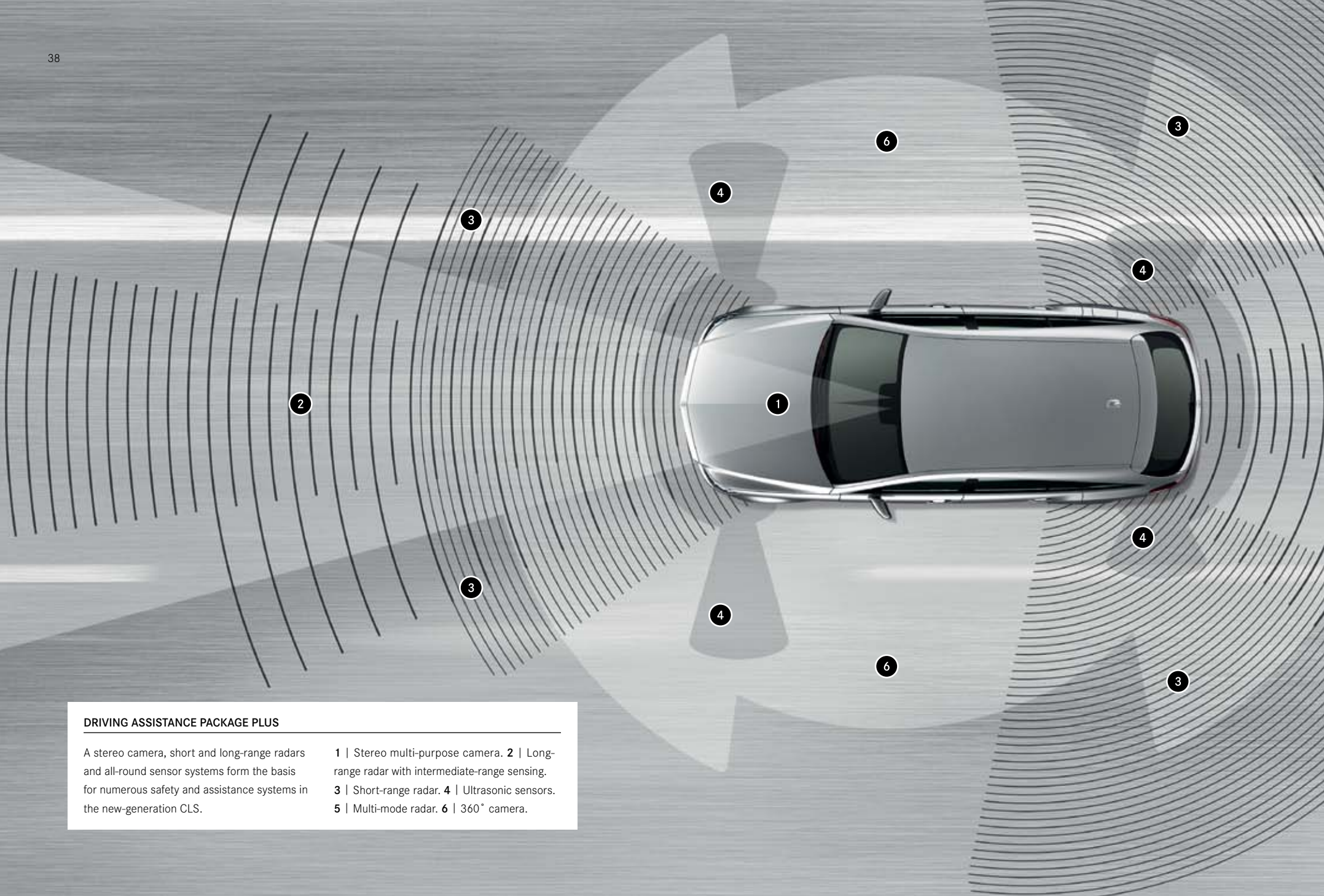

DRIVING ASSISTANCE PACKAGE PLUS

A stereo camera, short and long-range radars and all-round sensor systems form the basis for numerous safety and assistance systems in the new-generation CLS.

1 | Stereo multi-purpose camera. 2 | Long-range radar with intermediate-range sensing.
3 | Short-range radar. 4 | Ultrasonic sensors.
5 | Multi-mode radar. 6 | 360° camera.

Driving Assistance package Plus. Dangers minus.

Your eyes are focused on the road whilst driving. You look over your shoulder before overtaking. And you regularly check your rear-view mirror, not just when reversing. But even the very best drivers are unable to keep an eye on everything at the same time. Time for some enhanced protection: the optionally available **Driving Assistance package Plus** comprises a wealth of complementary safety and assistance systems.

DISTRONIC PLUS with Steering Assist and Stop&Go Pilot helps you keep a safe distance from the vehicle in front and also stay in the middle of the lane, for example. In this way, the system provides a great deal of stress-relieving comfort, especially on long journeys and when following

vehicles in a queue of traffic. Brake Assist BAS PLUS with Cross-Traffic Assist and PRE-SAFE® Brake with pedestrian detection can reduce the risk of accident at junctions, rear-end collisions and collisions with pedestrians, particularly in urban traffic. Active Lane Keeping Assist and Active Blind Spot Assist provide assistance if the vehicle leaves its lane unintentionally or during lane changes if there is a danger of collision with other vehicles. One-sided braking intervention can help return the vehicle to its lane and prevent an accident. PRE-SAFE® PLUS extends the functions of the PRE-SAFE® anticipatory occupant protection system with preventive measures when a rear impact threatens.

5

SAFETY TAKES PRECEDENCE

The optional **Traffic Sign Assist** system is able to recognise speed limits, no-entry and no-overtaking signs and their cancellation, and display them to the driver. If the vehicle enters a road against the posted allowed direction of travel, a visual and acoustic warning is issued.



Park like a pro with the 360° camera.

The optionally available **Active Parking Assist with PARKTRONIC** makes it easier to find a parking space and also to enter or leave parking spaces. When activated, it automatically steers the vehicle into parallel and end-on parking spaces, relieving the driver of the work of steering and braking. The **360° camera** included in the optional **Parking package** provides you with a realistic all-round view when parking and manoeuvring thanks to the interaction of four cameras. The camera is switched on automatically when reverse gear is engaged. Alternatively,

it can be activated by the driver if required. The vehicle and its immediate surroundings can be shown as a bird's-eye view in the multimedia system display. Obstacles below the window line are also visible to the driver. If the driver does not wish to use Active Parking Assist, the PARKTRONIC electronic parking assistance system monitors the front and rear ends while the driver is manoeuvring the vehicle and warns the driver if a risk of collision is detected.

↘ FIND OUT MORE

Find free parking spaces using the **Mercedes-Benz App** for Audio 20 CD and the optional COMAND Online system. For all the information on these and many other apps, visit <http://apps.mercedes-benz.com>

Information from the **Digital Owner's Manual** can be called up directly in the vehicle and viewed on the central display. This interactive feature for the new-generation CLS can be accessed from the national Mercedes-Benz website for your country and is also available as an app for smartphone or tablet.

The reassuring feeling of driving a Mercedes-Benz.

We are the first automobile manufacturer worldwide to have developed an **integral safety concept**, aimed at avoiding accidents, ensuring ideal responses to dangers and lessening the consequences of accidents. For the occupants of a Mercedes and for all other road users, too.

SAFE DRIVING

The **ATTENTION ASSIST drowsiness detection system** serves to enhance driving safety in particular on long trips and during night-time driving. It can monitor the steering behaviour of the driver to recognise typical signs of drowsiness and severe loss of attention, and give a visual and audible warning of impending microsleep.

The **ADAPTIVE BRAKE system** enhances ride comfort and safety. With the anti-lock braking system (ABS) as a base function it helps the driver to master critical braking manoeuvres more safely, and also assists the driver with day-to-day convenience functions such as Hill-Start Assist.

COLLISION PREVENTION ASSIST PLUS gives the driver a visual warning if the distance to the vehicle travelling ahead is too short. If the risk of a collision is detected, the driver can receive an audible warning and braking assistance. If the driver fails to react, the speed can be reduced autonomously.

The optional **Blind Spot Assist** system employs radar sensors and can draw attention to one of the most serious sources of danger in road traffic. If another vehicle is detected in the blind spot area, a red triangle appears in the relevant exterior mirror. An acoustic warning additionally sounds if the driver indicates to change lane. The system is active at speeds between 30 and 250 km/h. The optional **Lane Keeping Assist** system is able to recognise when the vehicle is unintentionally drifting out of its lane at speeds between 60 and 200 km/h, duly warning the driver by means of pulsed vibrations on the steering wheel. Blind Spot Assist and Lane Keeping Assist also form part of the optional Lane Tracking package.

IN THE EVENT OF DANGER

The **PRE-SAFE®** anticipatory occupant protection system is able to identify critical driving situations in advance and to initiate precautionary measures to protect the vehicle's occupants when there is imminent danger of an accident. Such measures include reversible belt tensioning or automatic closing of the side windows, for example.

IN AN ACCIDENT

Extensive restraint systems can substantially reduce the risk of injury. These include three-point seat belts with pyrotechnic belt tensioners and belt force limiters. Furthermore, the **NECK-PRO head restraints** on the front seats are actively raised and moved forwards in the event of a rear impact to provide early support for the occupants' heads and reduce the risk of whiplash injuries. Numerous airbags protect the occupants in the event of an accident and can reduce the risk of serious injury.

AFTER AN ACCIDENT

Every Mercedes-Benz is perfectly trained in first aid. In the event of an accident, the engine can be shut down automatically and the central locking system can be unlocked, in addition to which the hazard warning lights and the interior emergency illumination can be activated. Finally, the **Mercedes-Benz emergency call system**, one of the basic connect me services (standard equipment), can send position data and important vehicle information, though it is to be hoped this will never be necessary.



Mercedes connect me. Connected in comfort.

Our innovative and individualised mobility, connectivity and services go by the name of Mercedes me. As part of this new Mercedes-Benz world of experience, **Mercedes connect me** fully integrates driver, vehicle and personal lifeworld. Basic Mercedes connect me services such as the Mercedes-Benz emergency call system or Breakdown Management offer immediate assistance.

Remote Online is a pre-installation which allows the use of further – separately available – Mercedes connect me services such as the Parked Vehicle Locator function. Remote Online is optionally available in conjunction with the standard-fit Audio 20 CD multimedia system or included as part of the optional COMAND Online multimedia system, which opens up the entire world of Mercedes connect me to you, including browser, navigation with Live Traffic Information (free of charge for three years) and numerous apps. The Mercedes connect me services will only be activated on your express request, with the exception of the automatically activated Mercedes-Benz emergency call system.

OPTIONAL PHENOMENAL: THE ENTERTAINMENT HIGHLIGHTS

The 1400-watt high-end surround sound system **Bang & Olufsen BeoSound AMG** is an impressive proposition with its 14 active high-end loudspeakers and 2 tweeters with LED lighting.

The **Harman Kardon® Logic 7® surround sound system** with 610-watt Harman Kardon® DSP amplifier and booster delivers authentic surround sound.

COMAND Online offers navigation, telephone, audio, video and internet on a 20.3 cm display with intuitive control via Controller and LINGUATRONIC voice-operated control system.

The **Garmin® MAP PILOT** transfers all the benefits of a Garmin® navigation system to the Audio 20 CD multimedia system – with user-friendly navigation, precise map data and excellent route guidance.





Customised comfort.

Lapses in concentration occur sooner or later on longer trips, often due to back fatigue. The optionally available **Active Multicontour Seat package** with massage and dynamic function helps to alleviate back tension. Via the central display, the various air chambers in the driver and front passenger seat can be programmed with individual settings before setting off on a journey – from seat cushion depth via the side bolsters to the position and curvature of the backrest. A lumbar adjustment gives support to the spine. The massage function with seven zones and two selectable intensity settings further enhances the outstanding level of comfort on long journeys.

Do you prefer more dynamic driving? On winding routes or when adopting a sporty driving style, the seat side bolsters adjust dynamically, meaning that the active multicontour seats offer even more support, depending on the steering angle, lateral acceleration and speed of the car.

FIRST-CLASS COMFORT FOR THE SECOND ROW

Luxurious **individual rear seats** separated by a centre console with folding armrest emphasise the individuality of the entire CLS Coupé interior. Up to five people can enjoy all the CLS Shooting Brake has to offer – thanks to an **additional rear seat** in place of the centre console.

Space on demand.

The **EASY-PACK tailgate** makes it easy to carry items in the generously sized load compartment of the CLS Shooting Brake. For easy loading and unloading, it opens and closes by electro-mechanical means at the push of a button. To prevent the door from bumping against any objects, it can be stopped in any position and its opening angle can be limited up to the edge of the roof. Thanks to the separately folding **EASY-PACK quickfold rear seats** (also available for the Coupé as an option), there is an abundance of space in the load compartment – up to 1550 litres in the CLS Shooting Brake.

ELEGANT AND PRACTICAL

designo load compartment floor made from American open-pore cherry wood with black inlay work in dark fumed oak, optionally available for the CLS Shooting Brake.

Effective protection from prying eyes for the load compartment of the CLS Shooting Brake thanks to the pull-out **load compartment cover** with practical retractor mechanism.

The optionally available pull-out and height-adjustable **EASY-PACK boot box** allows smaller items such as laptops, briefcases or clothing to be stowed securely so that they do not slip or slide in the CLS Coupé (max. load capacity 10 kg, adjustable from 5 to 55 l).







Sets the heart racing. And that's before you even start off.

Maximum performance wherever you look – hallmarks of the **CLS 63 AMG** and the **CLS 63 AMG 4MATIC**. The front apron in A-wing design, the AMG light-alloy wheels and the AMG performance steering wheel are just three examples.

HIGHLIGHTS – EXTERIOR

- AMG radiator grille with silver-chrome double louvres and “AMG” lettering
- AMG front apron in A-wing design with trim strip in silver chrome, flics in black
- AMG side sill panels and wider front wings
- AMG triple-spoke light-alloy wheels, painted in titanium grey with a high-sheen finish, with 255/35 R 19 front tyres and 285/30 R 19 rear tyres
- AMG rear apron with diffuser insert and AMG sports exhaust system with two chromed twin tailpipe trim elements
- AMG spoiler lip on the boot lid (Coupé)

HIGHLIGHTS – INTERIOR

- AMG instrument cluster with AMG main menu, including RACETIMER and AMG start-up display
- AMG performance steering wheel in nappa leather, in 3-spoke design with flattened bottom section
- AMG DRIVE UNIT with E-SELECT lever
- AMG sports seats in perforated PASSION leather with multicontour-seat and memory function
- AMG sports pedals in brushed stainless steel with rubber studs



The stuff of dreams: the AMG Night package.

From the race track directly to your dinner appointment: the optionally available AMG Night package highlights the expressive and sporty character of the AMG models in extravagant fashion. With design elements painted in high-gloss black for drivers with exquisite taste.



AMG NIGHT PACKAGE AT A GLANCE

A-wing of AMG front apron and A-wing trim strip in high-gloss black

AMG side sill panel inserts in high-gloss black

Exterior mirror housings in high-gloss black

Window surrounds and beltline trim strips in high-gloss black

A very easy decision: the AMG Carbon-Fibre packages.

Elegance with a bold, sporty note: high-quality details in carbon fibre available as an option lend the AMG models even more dynamism when viewed from any angle, providing effective contrasts with the distinctive carbon structure trim.

AMG EXTERIOR CARBON-FIBRE PACKAGE I (ONLY AVAILABLE FOR COUPÉ)

AMG front apron A-wing in carbon fibre

Insert in AMG side sill panels in carbon fibre

Carbon-fibre diffuser insert in AMG rear apron

AMG EXTERIOR CARBON-FIBRE PACKAGE I (ONLY AVAILABLE FOR COUPÉ)

AMG carbon-fibre exterior mirror housing

AMG spoiler lip in carbon fibre

AMG EXTERIOR CARBON-FIBRE PACKAGE (ONLY AVAILABLE FOR SHOOTING BRAKE)

AMG front apron A-wing in carbon fibre

Insert in AMG side sill panels in carbon fibre

Carbon-fibre diffuser insert in AMG rear apron

ALSO AVAILABLE FOR SHOOTING BRAKE

AMG carbon-fibre exterior mirror housings







Super athlete on the outside. Superior on the inside.

The **CLS 63 AMG S-Model 4MATIC** has the air of an exceptional athlete. And this impression is not a misleading one. Thanks to the V8 engine with 430 kW (585 hp) and the combination of the traction benefits of an all-wheel-drive vehicle with the driving enjoyment provided by a rear axle differential lock. One thing becomes clear just hundredths of a second after getting in: you have already reached your most exciting destination.

HIGHLIGHTS – EXTERIOR

AMG 10-spoke light-alloy wheels, painted in matt titanium grey, rim flange with a high-sheen finish, with 255/35 R 19 front tyres and 285/30 R 19 rear tyres

AMG Performance 4MATIC all-wheel drive with AMG rear axle differential lock

Brake callipers painted red

AMG sports exhaust system with two chrome-plated twin tailpipe trim elements

HIGHLIGHTS – INTERIOR

AMG front door sill panels with white LED illumination

AMG instrument cluster with red appliqué and “S-Model” lettering

AMG performance steering wheel in black nappa leather/DINAMICA microfibre with 3 spokes and flattened bottom section

Interior with light contrasting topstitching and silver-coloured seat belts (not in conjunction with silk beige)

CLS 63 AMG technology.

Impressive power and fuel economy, racetrack performance and functionality – certainly not contradictory terms for the CLS 63 AMG. Its **AMG 5.5-liter V8 biturbo engine** has an output of 410 kW (557 hp) and a torque of 720 Nm or, in the S-Model, a staggering 430 kW (585 hp) and 800 Nm of torque.

The Mercedes-AMG-developed **performance-oriented 4MATIC all-wheel drive** (CLS 63 AMG 4MATIC and CLS 63 AMG S-Model 4MATIC) with a torque split of 33:67 provides the ideal means of transferring this power to the road – or to the racetrack.

With seven gears, four modes, RACE START function and double declutching function, the **AMG SPEEDSHIFT MCT 7-speed sports transmission** allows extremely dynamic acceleration, incredibly short shift times and a fuel-saving driving style.

With its adjustable, electronically controlled damping system, the **AMG RIDE CONTROL sports suspension** ensures exciting driving dynamics and the brand's hallmark comfort on long journeys. The front axle features steel suspension while the rear axle has AMG-specific air suspension.



AMG Performance Studio.

The AMG Performance Studio provides a wide variety of options to enhance the attractiveness, performance and exclusivity of the CLS 63 AMG even further – from the AMG RIDE CONTROL performance suspension and the AMG ceramic high-performance composite braking system, through to the AMG performance steering wheel in black nappa leather/DINAMICA microfibre. The AMG Performance Studio is also able to cater for individual customer requirements.

AMG ceramic high-performance composite braking system
(CLS 63 AMG S-Model 4MATIC)

AMG rear axle differential lock (CLS 63 AMG Coupé)

AMG RIDE CONTROL performance suspension with tauter tuning
(CLS 63 AMG Coupé)

AMG Driver's package with top speed limited to 300 km/h
(Shooting Brake 280 km/h) and participation in driver training at
the AMG Driving Academy

AMG 10-spoke light-alloy wheels, painted in matt black, rim flange with
a high-sheen finish, with 255/35 R 19 front tyres and 285/30 R 19 rear tyres

AMG cross-spoke forged wheels, either painted titanium grey with surface
with a high-sheen finish or painted matt black with rim flange with a high-sheen
finish, each with 255/35 R 19 front tyres and 285/30 R 19 rear tyres

AMG performance steering wheel in black nappa leather/DINAMICA
microfibre with 3 spokes and flattened bottom section

AMG carbon-fibre/black piano lacquer trim

AMG front door sill panels with white LED illumination





Standard-fit head-turners.

With a new progressively dynamic front end, LED High Performance headlamps and LED tail lamps, the new-generation CLS boasts a comprehensive scope of details even in its standard guise.



- 1 The exciting exterior features a black diamond radiator grille, LED High Performance headlamps plus 25R/69R (Coupé) or 69R (Shooting Brake) light-alloy wheels.
- 2 On the left side, the twelve ergonomic function keys of the nappa leather **multifunction steering wheel** control the display menus in the instrument cluster. On the right side, the driver can adjust the volume for audio devices, and the telephone and navigation system, for example. Manual gear changes are also possible using the DIRECT SELECT steering wheel gearshift paddles.
- 3 The **Audio 20 CD** multimedia system with 20.3 cm display combines entertainment, information and communication. The functions: Radio, CD player, two USB connections (e.g. for external audio devices such as iPod® or iPhone®), SD card connection, hands-free function, internet capability and networking with mobile devices via Bluetooth®.
- 4 **THERMATIC** automatic climate control with two climate zones. Temperature, airflow and air distribution are controlled automatically.
- 5 The **EASY-PACK quickfold** rear seats make it easier to transport bulky items. To enable the greatest possible flexibility the two backrest sections can be folded down separately using the convenient controls in the boot, and without the head restraints having to be removed beforehand (optional in Coupé).

↘ FIND OUT MORE

As attractive as this overview may be, it only provides an initial impression. For the complete range of standard equipment please refer to the price list, which is also available for viewing online. You can also configure the new-generation CLS to your very own specifications at

www.mercedes-benz.com.

Everything you could wish for: optional extras.

THERMOTRONIC, MULTIBEAM LED, COMAND Online – technology that tangibly enhances your comfort, safety and multimedia options. Meaning more of your wishes can be fulfilled. Discover these and other individualisation options – in this brochure, on the price list or online.

- 1 **COMAND Online** with 20.3 cm display, navigation, telephone, audio, video, internet and lots more. **Climatised seats**. **THERMOTRONIC** automatic climate control with three climate zones and three climate styles. **KEYLESS GO** enables the vehicle to be opened, started and locked simply by carrying the electronic key with you.
- 2 **Heat-insulating, dark-tinted glass** in the rear side windows and rear window protects the rear seat passengers from prying eyes and direct sunlight.
- 3 The electric **sliding sunroof** provides pleasant, draught-free air circulation in the interior. The glass design means that the interior also has a brighter look and feel. A movable headlining affords protection against the sun. If it starts to rain, the roof automatically moves to the raised position.
- 4 The **MULTIBEAM LED** light system enables the headlamps to adjust quickly and precisely to the current traffic situation (further details on pages 4 and 36/37).
- 5 In the CLS Shooting Brake, the perceived quality of the luggage compartment can be enhanced further with the four **designer aluminium rails** on the load compartment floor. Thanks to rubber inserts they provide additional slip-resistance when transporting loads.





A beauty to behold: the Exclusive package.

A Mercedes-Benz is always something special. But this stylishly matched combination of choice materials and lavish details means that even the aesthetics of a CLS can be further enhanced.



Upholstery in single-tone Exclusive PASSION leather with high-quality seat cushions in semi-aniline leather (optional: upholstery in two-tone Exclusive PASSION leather)

Dashboard, beltline, door centre panels, armrests in the doors and centre console finished in nappa leather

Multifunction steering wheel in nappa leather

Multifunction sports steering wheel in nappa leather, with flattened bottom section (in conjunction with AMG Line or designo upholstery)

Optional: wood/leather steering wheel (not in conjunction with CLS 63 AMG, AMG Line or designo upholstery)

Ambient lighting

DINAMICA microfibre roof liner in black, crystal grey or silk beige depending on appointments colour

Velour floor mats in appointments colour, with nubuck border

Floor mats with "AMG" lettering (in conjunction with CLS 63 AMG or AMG Line)

Thrills in the fast lane: the Exterior Sports package.

A dazzling first impression created in fractions of a second. Eye-catchingly sporty touches for the 4- and 6-cylinder models.



- 1 Twin-pipe exhaust system with integrated rectangular polished stainless-steel tailpipe trim elements with black rear bumper insert, DIRECT CONTROL sports suspension (no-cost option: DIRECT CONTROL suspension with comfort-oriented tuning), brake callipers with "Mercedes-Benz" lettering and larger front brake discs
- 2 5-twin-spoke light-alloy wheels painted in Himalayas grey with a high-sheen finish, with 255/40 R 18 front tyres and 285/35 R 18 rear tyres
- 3 10-spoke light-alloy wheels painted in Himalayas grey with a high-sheen finish, with 255/40 R 18 front tyres and 285/35 R 18 rear tyres (option)
- 4 5-twin-spoke light-alloy wheels painted in Himalayas grey with a high-sheen finish, with 255/35 R 19 front tyres and 285/30 R 19 rear tyres (option)
- 5 5-twin-spoke light-alloy wheels painted in Himalayas grey with a high-sheen finish, with 255/35 R 19 front tyres and 285/30 R 19 rear tyres (option)



The ultimate in dynamism: AMG Line and AMG Line Plus.

Turn the CLS into a top athlete – with the AMG Line or AMG Line Plus.

1 HIGHLIGHTS OF AMG LINE

AMG bodystyling consisting of AMG front apron, diamond radiator grille in chrome, AMG rear apron with chrome trim and AMG side sill panels

AMG 5-spoke light-alloy wheels with 255/40 R 18 front tyres and 285/35 R 18 rear tyres, AMG multi-spoke light-alloy wheels with 255/35 R 19 front tyres and 285/30 R 19 rear tyres (option)

Twin-pipe exhaust system with rectangular polished stainless-steel tailpipe trim elements integrated in the bumper

DIRECT CONTROL sports suspension

3-spoke multifunction sports steering wheel in nappa leather, with flattened bottom section

Interior with light contrasting topstitching (in conjunction with black upholstery)

2–4 HIGHLIGHTS OF AMG LINE PLUS

AMG spoiler lip on boot lid (Coupé), AMG 7-twin-spoke light-alloy wheels, painted high-gloss black with a high-sheen finish, with 255/35 R 19 front tyres and 285/30 R 19 rear tyres

3-spoke AMG sports steering wheel in nappa leather, with red contrasting topstitching and flattened bottom section

Seat belts in red (optionally in black)

AMG sports seats with black leather upholstery and interior with red contrasting topstitching

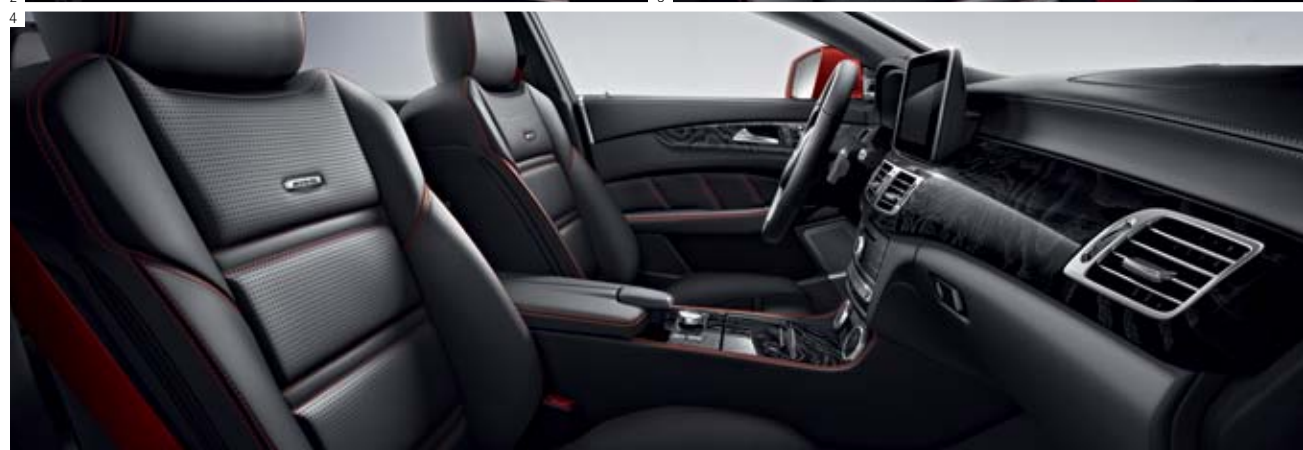

Athlete in black: the Night package.

Striking design elements in black underscore the sporty, expressive character of the CLS in conjunction with the AMG Line or the CLS 500 – from the louvre in the radiator grille to the exterior mirrors and the light-alloy wheels.



1 Louvre in the radiator trim painted in high-gloss black, front splitter in front bumper painted in high-gloss black, exterior mirrors painted in high-gloss black (painted in body colour in conjunction with obsidian black), beltline trim strip and window surrounds in anodised black, AMG 7-twin-spoke light-alloy wheels painted high-gloss black with a high-sheen finish, with 255/35 R 19 front tyres and 285/30 R 19 rear tyres (wheels optional for Night package in conjunction with AMG Line, standard for Night package in conjunction with AMG Line Plus)

2 Trim strip on AMG rear apron painted in high-gloss black, heat-insulating dark-tinted glass from the B-pillar rearwards (can be deselected on request), AMG 5-spoke light-alloy wheels painted black with a high-sheen finish, with 255/40 R 18 front tyres and 285/35 R 18 rear tyres (wheels part of Night package in conjunction with AMG Line)

3 5-twin spoke light-alloy wheels painted black with a high-sheen finish, with 255/40 R 18 front tyres and 285/35 R 18 rear tyres, part of Night package in conjunction with CLS 500/CLS 500 4MATIC

4 5-twin spoke light-alloy wheels painted black with a high-sheen finish, with 255/35 R 19 front tyres and 285/30 R 19 rear tyres, option for Night package in conjunction with CLS 500/CLS 500 4MATIC





Turning the design icon into a designer piece: designo.

The designo range for the CLS gives you options for further enhancing the car with exclusive and individual appointments. The two designo interior concepts with upholstery in fine designo semi-aniline leather (diamond design) or the finest designo nappa leather for the AMG models (piping design) impress with their stylish mix of contrasting colours and high-quality contrasting topstitching, for example.

THE EXTRAS OF YOUR CHOICE

The designo paint finishes are available in six colours.

The interior in classic red/black boasts a progressively sporty ambience. Here the seats and door centre panels in classic red plus red topstitching create an effective contrast against the black interior, including a high-gloss black ash wood trim.

For stylish luxury: the interior in saddle brown/silk beige with satin-finish light brown poplar wood trim (the pictures show the optional high-gloss brown linestructure lime wood trim). In addition to the seats, there are further elements finished in saddle brown such as the upper part of the dashboard and the beltlines.

Simply divine: designo DINAMICA microfibre roof liner, available in black, silk beige or crystal grey.



DISCOVER ALL THE BEAUTY OF DESIGNO

Configure your choice of interior appointments at www.mercedes-benz.com or ask your authorised Mercedes-Benz dealer.

The real thing or nothing: Genuine Accessories.

Given that the CLS is such a masterpiece of engineering, the accessories should be of equally outstanding quality. And ours are. The **Apple iPad® Rear Integration Plus** system is an ergonomic and crash-resistant solution for attaching your iPad®, for instance. The holder can be tilted as well as rotated through 90°, and it keeps all the connections free. Plus the battery can be charged via an integrated USB interface using your charging cable.

FROM MERCEDES – FOR MERCEDES

The **5-twin-spoke light-alloy wheels** are painted Himalayas grey with a high-shine finish. Their tyres: 255/40 R 18 (front) and 285/35 R 18 (rear).

The **multi-spoke light-alloy wheels** are painted Himalayas grey. Their tyres: 255/35 R 19 (front) and 285/30 R 19 (rear).

The **rear spoiler** from Mercedes-Benz further improves the aerodynamics of the CLS Coupé. It blends in harmoniously with the contours of the car to create an exceptionally sporty design.

Illuminated Mercedes star: the star centred in the radiator grille will light up courtesy of fibre-optic and LED technology when the vehicle is locked and unlocked by remote control, and when a door, the boot lid or the tailgate is opened.

Aerodynamic **roof box** designed to fit the CLS, made from extremely durable material. Fast, optimised attachment to the separately available basic carrier bars. Easy loading and unloading as it can be opened and closed on both sides.

↳ **DISCOVER THE ENTIRE RANGE**
Now online at www.mercedes-benz-accessories.com





The perfect way to complete your style.

Wheels are indispensable on technical grounds, of course. But on an emotional level, too, perfect wheels are an absolutely crucial ingredient of many people's dream car. With this in mind, we have put together an attractive selection for you.

STANDARD EQUIPMENT AND OPTIONAL EXTRAS

25R 10-spoke light-alloy wheels with 245/45 R 17 tyres (standard for 4-cylinder CLS Coupé models)

69R Multi-spoke light-alloy wheels, painted silver, with 245/45 R 17 tyres (CLS Coupé: standard for 6-cylinder models, option for 4-cylinder models; CLS Shooting Brake: standard for 4- and 6-cylinder models)

40R Multi-spoke light-alloy wheels, painted silver, with 255/40 R 18 tyres (standard for CLS 500/CLS 500 4MATIC, option for 4- and 6-cylinder models)

R71 10-spoke light-alloy wheels painted in Himalayas grey with a high-sheen finish, with 255/40 R 18 front tyres and 285/35 R 18 rear tyres (option)

22R 5-twin-spoke light-alloy wheels painted in Himalayas grey with a high-sheen finish, with 255/40 R 18 front tyres and 285/35 R 18 rear tyres (option, part of Exterior Sports package)

83R 5-twin spoke light-alloy wheels painted black with a high-sheen finish, with 255/40 R 18 front tyres and 285/35 R 18 rear tyres (part of Night package in conjunction with CLS 500/CLS 500 4MATIC)

R90 5-twin-spoke light-alloy wheels painted in Himalayas grey with a high-sheen finish, with 255/35 R 19 front tyres and 285/30 R 19 rear tyres (option)

R17 5-twin-spoke light-alloy wheels painted in Himalayas grey with a high-sheen finish, with 255/35 R 19 front tyres and 285/30 R 19 rear tyres (option)

84R 5-twin spoke light-alloy wheels painted black with a high-sheen finish, with 255/35 R 19 front tyres and 285/30 R 19 rear tyres (option for Night package in conjunction with CLS 500/CLS 500 4MATIC)



782



644



662



752 72R



63



788



797



799



665 R70



AMG

790 AMG 5-spoke light-alloy wheels with 255/40 R 18 front tyres and 285/35 R 18 rear tyres (part of AMG Line)

782 AMG 5-spoke light-alloy wheels painted in black with a high-sheen finish, with 255/40 R 18 front tyres and 285/35 R 18 rear tyres (part of Night package in conjunction with AMG line)

788 AMG multi-spoke light-alloy wheels with 255/35 R 19 front tyres and 285/30 R 19 rear tyres (option in conjunction with AMG Line)

644 AMG 7-twin-spoke light-alloy wheels painted in high-gloss black with a high-sheen finish, with 255/35 R 19 front tyres and 285/30 R 19 rear tyres (part of AMG Line Plus, option for Night package in conjunction with AMG line)

797 AMG triple-spoke light-alloy wheels painted in titanium grey with a high-sheen finish, with 255/35 R 19 front tyres and 285/30 R 19 rear tyres (standard for CLS 63 AMG Coupé and CLS 63 AMG 4MATIC)

662 AMG 10-spoke light-alloy wheels painted in matt titanium grey, rim flange with a high-sheen finish, with 255/35 R 19 front tyres and 285/30 R 19 rear tyres (standard for CLS 63 AMG S-Model 4MATIC)

799 AMG multi-spoke forged wheels, painted titanium grey with high-sheen surface, with 255/35 R 19 front tyres and 285/30 R 19 rear tyres (option for AMG models)

752 AMG 10-spoke light-alloy wheels painted matt black, rim flange with high-sheen finish, with 255/35 R 19 front tyres and 285/30 R 19 rear tyres (option for AMG models)

665 AMG cross-spoke forged wheels painted matt black, rim flange with high-sheen finish, with 255/35 R 19 front tyres and 285/30 R 19 rear tyres (option for AMG models)

GENUINE ACCESSORIES

72R 10-spoke light-alloy wheels painted titanium silver, with 245/45 R 17 tyres (accessory wheels optional ex factory for 4- and 6-cylinder models)

R70 5-twin-spoke light-alloy wheels painted titanium silver, with 255/40 R 18 front tyres and 285/35 R 18 rear tyres (accessory wheels optional ex factory)

↘ FURTHER WHEELS

can be found on page 61 or in our accessories range at www.mercedes-benz-accessories.com



More than simply a star. A whole universe.

The range of **services from Mercedes-Benz**. Every Mercedes brings with it as a standard feature a reassuring feeling of safety on the road. But if you ever do need help, we're here for you around the clock. You can reach us from anywhere in Europe on the toll-free number 00800 1 777 7777¹ (or alternatively direct through Mercedes-Benz Contact²).

Ensuring that you can keep moving in the event of a technical breakdown, accident, vandalism or even misfuelling, the **Mercedes-Benz mobility package Mobilo**³ is included as part of the standard specification. It covers the cost of local assistance, for example for towing your car away or for a replacement vehicle – and will do so in more than 40 countries across Europe for up to 30 years³. Furthermore, for the first four years following initial registration of the vehicle, Mobilo offers special mobility services in the case of workshop visits involving warranty or goodwill situations.

Avoid unexpected workshop costs⁴: a **Mercedes-Benz Service Contract** covers unforeseeable repairs, maintenance or wear parts, depending on the specific contract. Your local Mercedes-Benz dealer will be pleased to provide information about available Service Contracts and terms and conditions.

Mercedes-Benz Financial Services. Drive a Mercedes-Benz and remain flexible when it comes to payment: our attractive leasing and finance products make this possible – matched to your requirements and needs. We will also be happy to offer you a range of detailed insurance proposals. Just speak to your Mercedes-Benz dealer, who will be happy to provide information about our current range of financial services, terms and conditions.

¹ Alternatively: +49 69 95 30 72 77. Calls to a landline are chargeable. ² Calls from a mobile phone to a landline are chargeable. ³ When it expires, (four years after initial registration) Mobilo can be extended to up to 30 years from one service to the next by your authorised Mercedes-Benz service partner. ⁴ Mercedes-Benz service contract terms and conditions apply. Illustration right: MERCEDES AMG PETRONAS F1 W05, 2014 season.

Enjoy the digital experience of Mercedes-Benz –

wherever you happen to be. Thanks to a range of offers optimised for smartphones and tablet computers, you can immerse yourself in the world of Mercedes-Benz even while on the move.

Insights into the full product range, a varied programme of entertainment and direct contact to a wide variety of services await you. Take an interactive tour with the **Interactive Owner's Manual**, for example, to get to know your dream car better. Experience the various functions in detail, take a close-up look at what's going on inside or explore the benefits of the particular model on your national Mercedes-Benz website.

With the “**Mercedes-Benz Guides**” app you can also explore the highlights of the various vehicles off-line. The app is available free of charge from the iTunes Store® (iOS) or the Google Play Store (Android).

Incidentally, our TV and magazine media are also available to watch and read digitally. Explore the whole brand world for yourself at **www.mercedes-benz.com**. Just click to take a look.

The **fascination of Mercedes-Benz**. A car whose name brings a gleam to the eyes of people all over the world, one that has featured in many a movie and been sung about in international hits, is surely far more than just a car. How did it come to this?

Discover just what has been moving the world for more than 125 years and take a fascinating journey through time as well as through the history of the automobile, in the **Mercedes-Benz Museum**. More than 1500 exhibits over a display area of 16500 square metres demonstrate the unique heritage and innovative power of the inventor of the automobile, among them one-off models such as the oldest Mercedes still in existence, built in 1902, or the legendary “Gullwing” cars. Welcome to a place of innovation: www.mercedes-benz-classic.com/museum

What would the history of Mercedes-Benz be like without **motorsport**? What would motorsport be without Mercedes-Benz? The first vehicle ever to win an automobile race was powered by a Daimler engine. The first Mercedes was a racing car. The Silver Arrows – a true legend. Out of this glorious past has grown an exciting present: the MERCEDES AMG PETRONAS Formula 1 team and the DTM Mercedes AMG C-Coupés fight it out weekend after weekend for points and victory.



Technical data.

DIESEL ENGINES

No. of cylinders/arrangement
Total displacement in cc
Rated output ¹ in kW (hp) at rpm
Rated torque ¹ in Nm at rpm
Transmission
Acceleration from 0 to 100 km/h in sec. [Shooting Brake]
Top speed, approx. in km/h [Shooting Brake]
Tyre size, front
Tyre size, rear
Fuel
Fuel consumption ³ in l/100 km
Urban [Shooting Brake]
Extra-urban [Shooting Brake]
Combined [Shooting Brake]
CO ₂ emissions ³ in g/km, combined [Shooting Brake]
Emission class ⁴ /efficiency class ⁵ [Shooting Brake]
Tank capacity, of which reserve, approx. in l
Boot capacity ⁶ in l [Shooting Brake]
Kerb weight ⁷ in kg [Shooting Brake]
Perm. GVW in kg [Shooting Brake]

CLS 220 BlueTEC	CLS 250 BlueTEC	CLS 250 BlueTEC 4MATIC	CLS 350 BlueTEC	CLS 350 BlueTEC 4MATIC
4/in-line	4/in-line	4/in-line	6/V	6/V
2143	2143	2143	2987	2987
125 (170)/3000–4200	150 (204)/3800	150 (204)/3800	190 (258)/3600	185 (252)/3600
400/1400–2800	500/1600–1800	500/1600–1800	620/1600–2400	620/1600–2400
9G-TRONIC	9G-TRONIC	7G-TRONIC PLUS	9G-TRONIC	7G-TRONIC PLUS
8.3 [8.6]	7.5 [7.7]	7.9 [8.1]	6.5 [6.6]	6.7 [6.8]
226 [220]	242 [235]	236 [229]	250 ² [245]	245 [240]
245/45 R 17	245/45 R 17	245/45 R 17	245/45 R 17	245/45 R 17
245/45 R 17	245/45 R 17	245/45 R 17	245/45 R 17	245/45 R 17
Diesel	Diesel	Diesel	Diesel	Diesel
5.6–5.5 [5.7]	5.6–5.5 [5.8]	6.4 [6.6]	6.4 [6.6]	7.4–7.3 [8.3–8.1]
4.1 [4.4–4.3]	4.1 [4.5–4.4]	4.6 [5.0–4.8]	4.8 [5.1]	5.4–5.3 [6.0–5.8]
4.7–4.6 [4.9]	4.7–4.6 [5.0]	5.3 [5.6–5.5]	5.4 [5.7]	6.2–6.1 [6.8–6.6]
122 [127]	122 [130]	140 [147–146]	142–140 [149]	162–160 [178–174]
Euro 6/A+ [Euro 6/A+]	Euro 6/A+ [Euro 6/A]	Euro 6/A [Euro 6/A]	Euro 6/A [Euro 6/A]	Euro 6/B [Euro 6/B]
59/8.0	59/8.0	59/8.0	59/8.0	59/8.0
475 [590–1550]	475 [590–1550]	475 [590–1550]	475 [590–1550]	475 [590–1550]
1790 [1845]	1815 [1885]	1875 [1955]	1845 [1935]	1915 [1995]
2275 [2370]	2300 [2410]	2360 [2480]	2330 [2460]	2400 [2520]

¹ Figures for rated output and rated torque in accordance with Directive 80/1269/EEC in the currently applicable version. ² Electronically governed. ³ The figures shown were obtained in accordance with the prescribed measuring process (Directive [EC] 715/2007 in the currently applicable version). Note according to Directive 1999/94/EC in the currently applicable version: The figures are not based on an individual vehicle and do not constitute part of the product offer; they are provided solely for purposes of comparison between the different vehicle models. ⁴ Valid only within the European Union. Country-specific variations possible.

PETROL ENGINES

	CLS 400	CLS 400 4MATIC	CLS 500	CLS 500 4MATIC	CLS 63 AMG	CLS 63 AMG 4MATIC	CLS 63 AMG S-Model 4MATIC
No. of cylinders/arrangement	6/V	6/V	8/V	8/V	8/V	8/V	8/V
Total displacement in cc	3498	3498	4663	4663	5461	5461	5461
Rated output ¹ in kW (hp) at rpm	245 (333)/5250-6000	245 (333)/5250-6000	300 (408)/5000-5750	300 (408)/5000-5750	410 (557)/5500	410 (557)/5500	430 (585)/5500
Rated torque ¹ in Nm at rpm	480/1200-4000	480/1200-4000	600/1600-4750	600/1600-4750	720/1750-5250	720/1750-5250	800/1750-5000
Transmission	7G-TRONIC PLUS	7G-TRONIC PLUS	9G-TRONIC	7G-TRONIC PLUS	AMG SPEEDSHIFT MCT 7-speed sports	AMG SPEEDSHIFT MCT 7-speed sports	AMG SPEEDSHIFT MCT 7-speed sports
Acceleration from 0 to 100 km/h in sec. [Shooting Brake]	5.3 [5.4]	5.3 [5.4]	4.8 [4.9]	4.8 [4.9]	4.2 [-]	3.7 [3.8]	3.6 s [3.7]
Top speed, approx. in km/h [Shooting Brake]	250 ² [250 ²]	250 ² [250 ²]	250 ² [250 ²]	250 ² [250 ²]	250 ² [-]	250 ² [250 ²]	250 ² [250 ²]
Tyre size, front	245/45 R 17	245/45 R 17	255/40 R 18	255/40 R 18	255/35 ZR 19	255/35 ZR 19	255/35 ZR 19
Tyre size, rear	245/45 R 17	245/45 R 17	255/40 R 18	255/40 R 18	285/30 ZR 19	285/30 ZR 19	285/30 ZR 19
Fuel	Premium petrol	Premium petrol	Premium petrol	Premium petrol	Super Plus petrol	Super Plus petrol	Super Plus petrol
Fuel consumption ³ in l/100 km							
Urban [Shooting Brake]	10.0 [10.3-10.2]	10.8-10.7 [11.0-10.9]	11.7 [12.1]	13.4 [13.3]	13.9 [-]	14.4 [14.4]	14.4 [14.4]
Extra-urban [Shooting Brake]	5.7 [6.0-5.9]	6.5-6.4 [6.8-6.6]	6.6 [6.8]	7.4 [7.8]	7.6 [-]	8.0 [8.4]	8.0 [8.4]
Combined [Shooting Brake]	7.3 [7.6-7.5]	8.0 [8.4-8.3]	8.5 [8.8]	9.6 [9.8]	9.9 [-]	10.4 [10.6]	10.4 [10.6]
CO ₂ emissions ³ in g/km, combined [Shooting Brake]	170-169 [177-175]	187 [195-192]	199 [205]	224 [229]	231 [-]	243 [248]	243 [248]
Emission class ⁴ /efficiency class ⁵ [Shooting Brake]	Euro 6/C [Euro 6/C]	Euro 6/D [Euro 6/D]	Euro 6/D [Euro 6/D]	Euro 6/E [Euro 6/E]	Euro 6/F [-]	Euro 6/F [Euro 6/F]	Euro 6/F [Euro 6/F]
Tank capacity, of which reserve, approx. in l	59/8.0	59/8.0	80/9.0	80/9.0	66/14.0	66/14.0	66/14.0
Boot capacity ⁶ in l [Shooting Brake]	520 [590-1550]	520 [590-1550]	520 [590-1550]	520 [590-1550]	520 [-]	520 [550-1550]	520 [550-1550]
Kerb weight ⁷ in kg [Shooting Brake]	1775 [1845]	1835 [1915]	1890 [1955]	1940 [2005]	1870 [-]	1945 [2025]	1945 [2025]
Perm. GVW in kg [Shooting Brake]	2260 [2370]	2320 [2440]	2375 [2480]	2425 [2530]	2390 [-]	2415 [2560]	2415 [2560]

⁵ Determined on the basis of the measured CO₂ emissions, taking into account the mass of the vehicle. ⁶ Figures according to Directive 70/156/EEC, version 2000/40/EC. ⁷ The figures shown were obtained in accordance with Directive 92/21/EC, version 95/48/EC (kerb weight with fuel tank 90% full, driver, 68 kg, and luggage, 7 kg) for standard-specification vehicles. Optional extras and accessories will generally increase this figure and reduce the payload capacity accordingly. Figures in square brackets refer to the CLS Shooting Brake. Further technical data are available at www.mercedes-benz.com

Coupé dimensions.

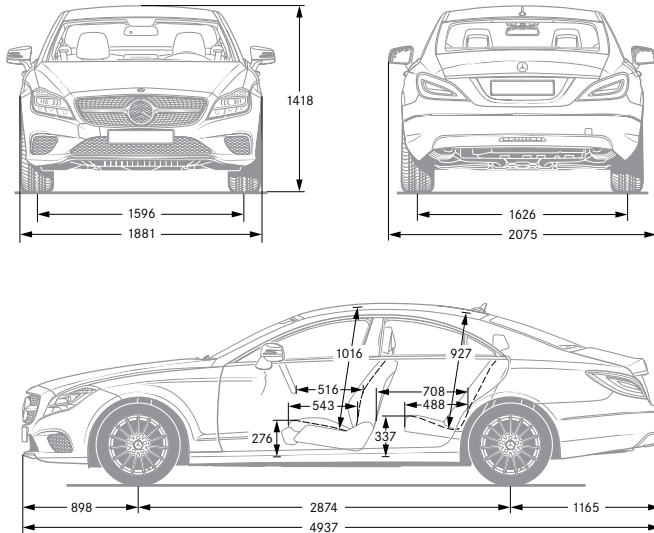

Shooting Brake dimensions.

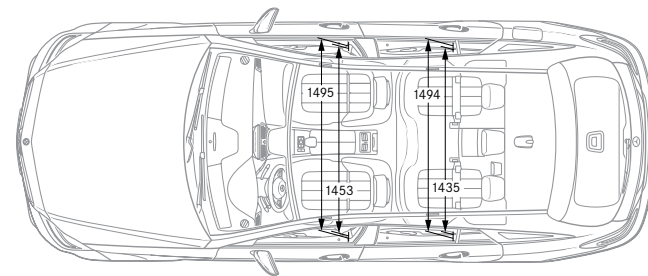
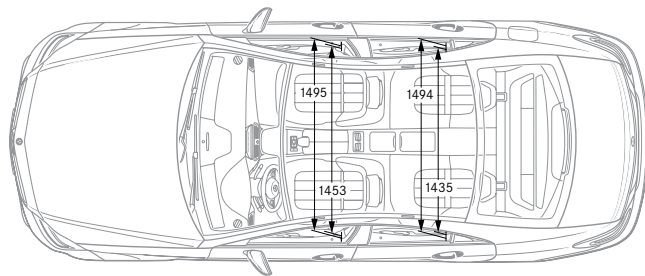
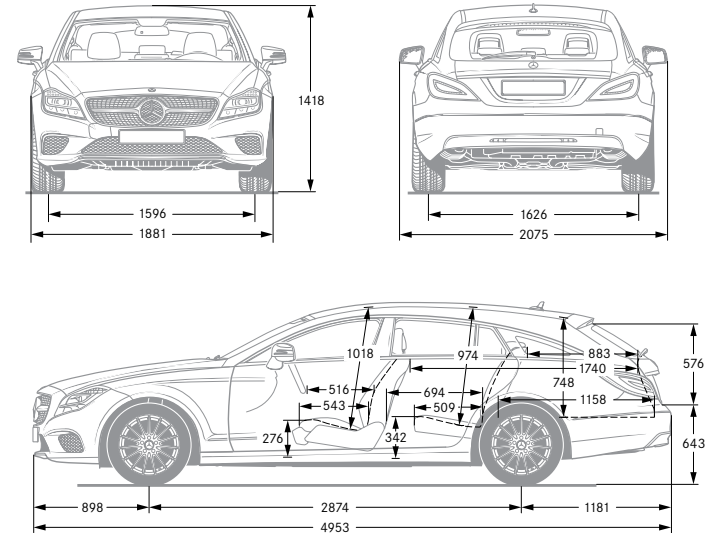

All dimensions in millimetres. The dimensions shown are mean values and apply to standard-specification, unladen vehicles.

Upholstery and trim.

Upholstery

- 201 black^{1, 2}
- 211 black with light contrasting topstitching^{1, 3}
- 214 saddle brown/black¹
- 218 crystal grey/black¹
- 221 black with red contrasting topstitching^{1, 4}
- 225 porcelain/black¹
- 245 silk beige/espresso brown¹
- 501 black^{5, 6}
- 511 black with light contrasting topstitching^{1, 3, 6}
- 514 saddle brown/black^{1, 6}
- 518 crystal grey/black^{5, 6}
- 521 black with red contrasting topstitching^{1, 4, 6}
- 525 porcelain/black^{1, 6}
- 531 black with light contrasting topstitching^{6, 7}
- 545 silk beige/espresso brown^{5, 6}
- 701 black
- 801 black^{5, 8}
- 811 black with light contrasting topstitching^{1, 3}
- 814 saddle brown/black¹

- 818 crystal grey/black⁵
- 825 porcelain/black¹
- 831 black with light contrasting topstitching⁹
- 845 silk beige/espresso brown⁵
- 851 black with red contrasting topstitching^{1, 4}
- 964 saddle brown/silk beige^{1, 6}
- 967 classic red/black^{1, 6}
- 974 saddle brown/silk beige¹
- 977 classic red/black¹
- 984 saddle brown/silk beige^{6, 10}
- 987 classic red/black^{6, 10}
- 994 saddle brown/silk beige¹⁰
- 997 classic red/black¹⁰

Trim

- H07 high-gloss brown linestructure lime wood⁵
- H19 satin-finish light brown poplar wood¹¹
- H21 black piano lacquer^{5, 8}
- H73 AMG carbon fibre/black piano lacquer⁵
- 731 high-gloss brown burr walnut wood¹¹
- 736 high-gloss black ash wood¹²

ARTICO man-made leather/fabric



Leather

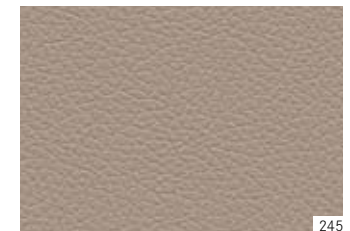

¹ Optional extra, not available for AMG models. ² Standard for CLS 500/CLS 500 4MATIC. ³ Only in conjunction with AMG Line. ⁴ Only in conjunction with AMG Line Plus. ⁵ Optional extra. ⁶ Only in conjunction with Exclusive package. ⁷ Optional extra for AMG S-Models. ⁸ Standard for AMG models. ⁹ Standard for AMG S-Models. ¹⁰ Optional extra for AMG models. ¹¹ No-cost option. ¹² Standard, optional for AMG models. For details of further design upholstery, please consult your Mercedes-Benz dealer.

Nappa leather/
Exclusive nappa leather

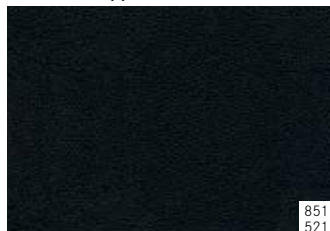

PASSION leather/
Exclusive PASSION leather

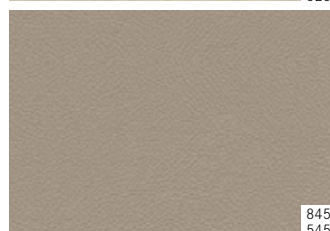
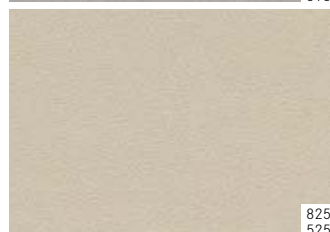
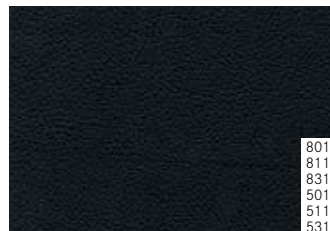

designo semi-aniline leather/
designo Exclusive semi-aniline leather



designo nappa leather¹⁰/
designo Exclusive nappa leather¹⁰



Trim

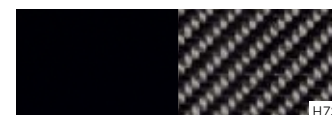

Paintwork.

Non-metallic paint

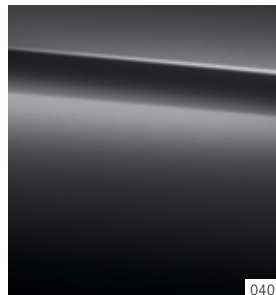

040

Metallic paints¹

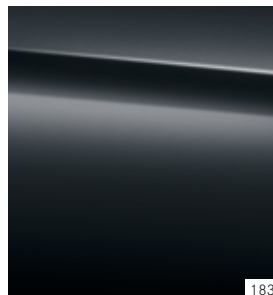

183



792

designo paints¹



795

designo manufaktur paints¹

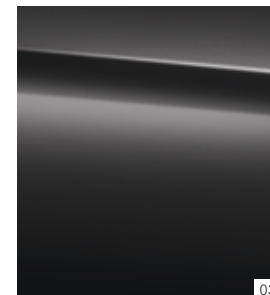

033

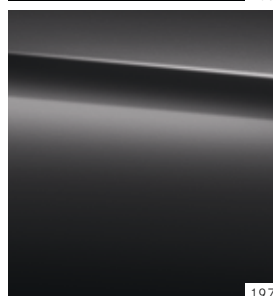

197

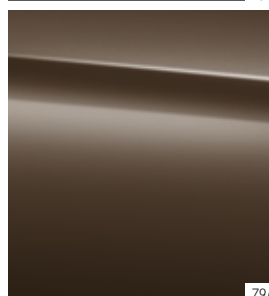

796



799

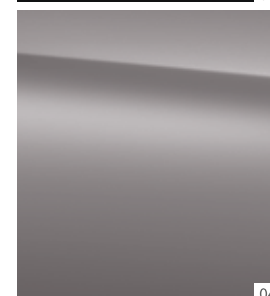

044

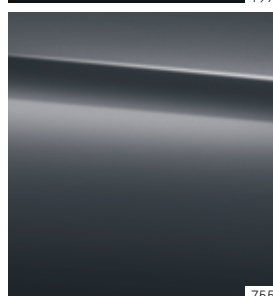

755



890

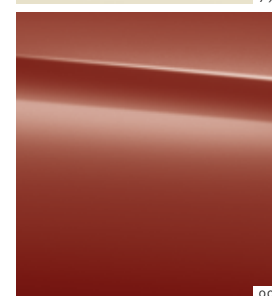

996



049



775



988

Non-metallic paint

040 black

Metallic paints¹

183 magnetite black

197 obsidian black

755 tenorite grey

775 iridium silver

792 palladium silver

796 citrine brown

890 cavansite blue

988 diamond silver

designo paints¹

795 designo manganite grey magno²

799 designo diamond white bright

996 designo hyacinth red metallic

designo manufaktur paints¹

033 designo mocha black metallic

044 designo allanite grey magno²

049 designo cashmere white magno²

¹ Optional. ² Matt paint.
For further individual designo paint finishes,
please consult your Mercedes-Benz dealer.

Take-back of end-of-life vehicles. At the end of its long life, you can return your CLS-Class to us for environment-friendly disposal in accordance with the European Union (EU) End-Of-Life Vehicle Directive. But that day lies a long way off.

A network of vehicle take-back depots and dismantlers has been established to make it as easy as possible for you to return your vehicle. You can leave it at any of these points free of charge and, by doing so, make an important contribution to completing the recycling process and conserving resources.

For further information about the recycling and disposal of end-of-life vehicles and take-back conditions, please visit your national Mercedes-Benz website.

Please note: Changes may have been made to the products since this brochure went to press (06.05.2014). The manufacturer reserves the right to make changes to the design, form, colour and specification during the delivery period, provided these changes, while taking into account the interests of the vendor, can be deemed reasonable with respect to the purchaser. Where the vendor or the manufacturer uses symbols or numbers to describe an order or the subject of an order, no rights may be derived solely from these. The illustrations may show accessories and items of optional equipment which are not part of standard specification. Colours may differ slightly from those shown in the brochure, owing to the limitations of the printing process. This brochure has been compiled by Daimler AG of Germany and is distributed internationally. It provides a general indication of the range of models, features, optional extras and/or colours available in various countries. Some of the models, features, optional extras and/or colours shown may not be available in your country or may only be available in a different specification. Additionally some models, features, optional extras and/or colours may only be available in combination with others. For current and more specific information in relation to the range of models, features, optional extras and/or colours available in your country, and their pricing, you should contact your nearest authorised Mercedes-Benz Passenger Car Dealer.

www.mercedes-benz.com