

The A-Class.



Mercedes-Benz

A blue-tinted photograph of a wet street corner. In the foreground, a dark tree trunk is on the left. The wet pavement reflects the light. In the background, there is a building with a window and a door. The overall mood is quiet and atmospheric.

The pulse of a new generation. The A-Class.

It is an unbridled attack: on your eyes, on your heart, on that which you normally expect from Mercedes-Benz. The A-Class is the car for a new era and a new generation. A car that wants it all – a design that is the spitting image of the future? Here it is. Unadulterated agility and efficient with it? Of course. Comfort and technology in a breathtaking symbiosis? Climb on in and experience it for yourself. Equipment and appointments options which are geared to your personality and not vice versa? Just let yourself be guided by your style. And when you are then finally sitting in it and drive the first of many, many exciting metres, you will feel it in the new A-Class – the pulse of a new generation.

The featured models at a glance:

2 | Mercedes-Benz A 250

polar silver metallic

AMG Line design and equipment line, AMG 5-twin-spoke light-alloy wheels, black ARTICO/DINAMICA microfibre upholstery, carbon-fibre-look trim

10 | Mercedes-Benz A 200

juniper red non-metallic

Style design and equipment line, 5-twin-spoke light-alloy wheels, black/white fabric/ARTICO upholstery, black matrix-look trim

16 | Mercedes-Benz A 250 Sport – engineered by AMG

polar silver metallic

AMG Line design and equipment line, AMG 5-spoke light-alloy wheels, RED CUT black leather upholstery, carbon-fibre-look trim

18 | Mercedes-Benz A 250 Sport – engineered by AMG

polar silver metallic

AMG Line design and equipment line, AMG rear aerofoil, AMG 5-spoke light-alloy wheels, RED CUT black leather upholstery, carbon-fibre-look trim

20 | Mercedes-Benz A 45 AMG 4MATIC

cirrus white non-metallic

AMG multi-spoke light-alloy wheels, Night package, black ARTICO/DINAMICA microfibre upholstery, carbon-fibre-look trim

Vision.

24 | Moving innovation

Drive system and chassis.

26 | Diesel engines

27 | Petrol engines

28 | Transmissions

30 | Chassis and suspension

Safety.

32 | Integral safety concept

Comfort.

36 | Multimedia systems

38 | Assistance systems

39 | Light and climate control

40 | Seats

41 | Roof and space

Model variants.

42 | Sports models A 250 Sport and A 250 Sport 4MATIC – engineered by AMG

AMG.

44 | A 45 AMG 4MATIC exterior

46 | A 45 AMG 4MATIC interior

48 | A 45 AMG 4MATIC technology

50 | AMG Performance Studio

Equipment and appointments.

52 | Design and equipment lines and packages, including upholstery and trim

72 | Standard equipment

73 | Optional extras

74 | Wheels

76 | Genuine accessories

78 | Services.

Facts and colours.

80 | Dimensions

80 | Paintwork

81 | Technical data



1 look*

*And you won't believe your eyes:
What a Mercedes!

Either for or against, complacency is not an option. Non-conformist from the outside and quite the style icon inside. It expels boredom from the street. And gives you an easy ride in the process. High-tech: it goes without saying. Safe: no question. Efficient: naturally. It could not be a more characteristic Mercedes. And at the same time very, very different. Hello, A-Class!



130 bpm*

*When the view leaves you speechless,
the heart speaks volumes.

An expression of pulsating life: defined edges alongside tautly tensioned surfaces: concave curves, convex sweeping lines – in a perfect rhythm for light shows. And sinewy with it, athletic like a coupé. Lit-up eyes included: this is what a portrait of the A-Class feels like.





1*

*Endless equipment options.
And only one that sets the tone.

Your head, your style, your personality, your A-Class. Three possible design and equipment lines, three confident statements: athletic and confident with Urban and Style or sporty through and through with the AMG Line. Even more “Me” with three optional Design packages: an extravagant exterior in the Night package, high-quality details in the Exclusive package, sporty presence in the AMG Exclusive package. The A-Class: a Mercedes-Benz where its genes are concerned. But it clearly takes after you.





Mercedes-Benz Apps

- Facebook
- Nachrichten
- Parkplatzsuche
- Morningstar Finanzen

22:00 22 °C

7.3 km
121

RADIO DISC

NAVI TEL

SYS OK

OK

AUTO ZONE

21 22.7

MODE A/C



800 x 480*

*The offline resolution:
The COMAND Online.

Sit at the wheel and steer the whole world. A full 17.8 cm display: your window to the web of possibilities. Surf in the browser, search with Google®, share on Facebook® and be there every bit of the way. And you won't be alone in any situation in the real world, either: the electric parking brake, Active Parking Assist, reversing camera and HOLD function support your motoring pleasure. Technology that makes it easier to be human.

> 1000 km*

*Every refuelling stop is something special.
Good for progress and bank balance alike.

The A-Class is a true endurance athlete. The economical consumption as low as 3.6 litres per 100 kilometres takes you further than you think. Thanks to efficient engines with direct injection and turbocharging. And the standard-specification ECO start/stop function which also helps to put the brakes on consumption at red traffic lights. The very essence of BlueEFFICIENCY.









5 + 11*

*More perception and less risk.

Whenever the 5 senses reach their limits they are on hand: 11 assistance systems. Standard equipment for the A-Class includes the radar-based COLLISION PREVENTION ASSIST safety system, the ATTENTION ASSIST system and Hill-Start Assist. Even more safety is available optionally: the DISTRONIC PLUS adaptive cruise control and the PRE-SAFE® system. Technologies which can keep danger at bay.





$$C_d = 0.27^*$$

*If you save on wind resistance, you also save on consumption.

The A-Class: a body that is so streamlined that the air runs out of breath. The result: a drag coefficient like that of notchback saloons. The best in its segment, in fact. This means lower fuel consumption and fewer fuelling stops. Pssst: this is also how we reduced the wind noise.









6.6 s*

*Quick sprint: 0 to 100 km/h in a flash.

Off and away with a lasting impression. A well-exercised heart as a drive system: high-torque and efficient 4-cylinder petrol and diesel engines. From one gear to another without any interruptions with the optional dual clutch transmission 7G-DCT. Your finger on the pulse of the road: the Sports Direct-Steer system and sports suspension in the optional Dynamic Handling package. An athlete where looks are concerned, too: with sports seats that have really earned their name and an optional diamond radiator grille. Don't drive off if the fun factor is any less than this.



A white Mercedes-AMG A45 is shown from a rear three-quarter view, driving on a racetrack. The car is in motion, with a blurred background of a sunset sky and a stone wall on the right. The text '450 Nm*' is prominently displayed in the upper right quadrant.

450 Nm*

*Refresh your knowledge of physics
in 4.6 seconds.

The A 45 AMG stands for sport, dynamism, power and above all for itself. Because with its AMG 2.0-litre 4-cylinder turbocharged engine it achieves 360 hp, making it the undisputed leader in its segment. This means more hp, more torque and more AMG, sending the vehicle shooting over the road and the adrenaline through your veins.

A silver Mercedes-AMG A45 is shown from a rear three-quarter view, driving on a racetrack. The track has a red and white curb. In the background, there are stacks of tires and a fence. The scene is lit with the warm glow of a sunset.

As low as 6.9 l*

*No other vehicle drives past so many filling stations with this much power.

With great strength the A 45 AMG also assumes a lot of responsibility. By way of example, with 360 hp and 450 Nm it consumes between 7.1 and 6.9 litres per 100 kilometres in the combined test cycle. Because for sports cars from Affalterbach every drop counts just as much as every tenth of a second.



What makes a car a Mercedes?

Deep-rooted traditions: in our case, it is innovative traditions that run deep. We have continually gone down previously uncharted avenues. Milestone by milestone. These ventures spawned the first vehicle with a crumple zone, the first ABS, the first diesel car. The first automobile. And whilst it's good to look back, looking forward is even better.

Mercedes me – welcome to a world that revolves entirely around you. We focus on people. No more so than when we developed a new platform for you to keep in close contact with Mercedes-Benz. With services that are tailored to your needs. “connect me” connects the vehicle to your world of experience, to everything that is important to you. “move me” provides new mobility solutions. And “inspire me” gives you an exclusive insight into the future of mobility. Your gateway to a fascinating world: www.mercedes.me



Mercedes-Benz Intelligent Drive – on the road to accident-free driving. We develop intelligent technologies which actively support the driver and noticeably relieve the driver's workload. Valuable assistants are already available in your Mercedes-Benz today: automatically helping to keep the car at a safe distance from the vehicle in front, braking when necessary and warning the driver of impending rear-end collisions or of vehicles in the blind spot. The sensor technology of the driving assistance and safety systems is interlinked intelligently. Potentially dangerous situations are identified earlier than ever – and ever more frequently avoided as a result. Discover the fascinating world of Mercedes-Benz Intelligent Drive at www.mercedes-benz-intelligent-drive.com

BlueEFFICIENCY – our vision of emission-free driving. Sustainability is a big word to which we lend real meaning in all that we do, down to the smallest details. From minimising the environmental impact of our production operations to alternative drive concepts.

We have major goals in our sights. What could be better than seeing them achieved on a long drive in a Mercedes?

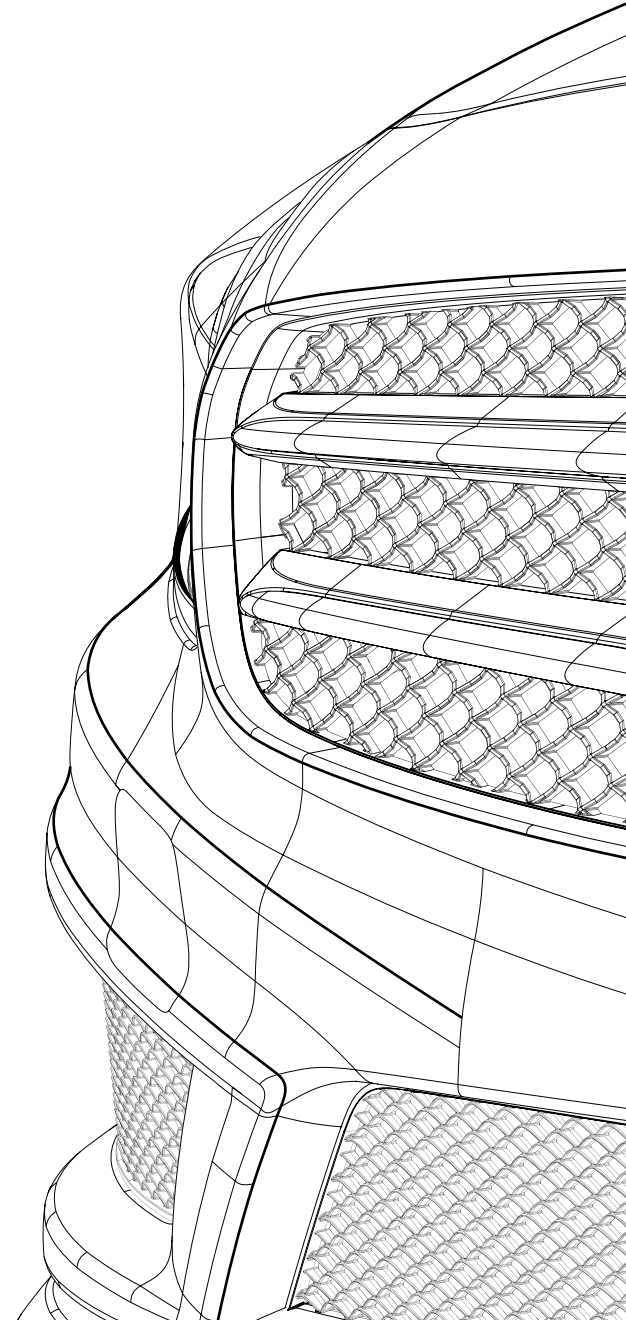

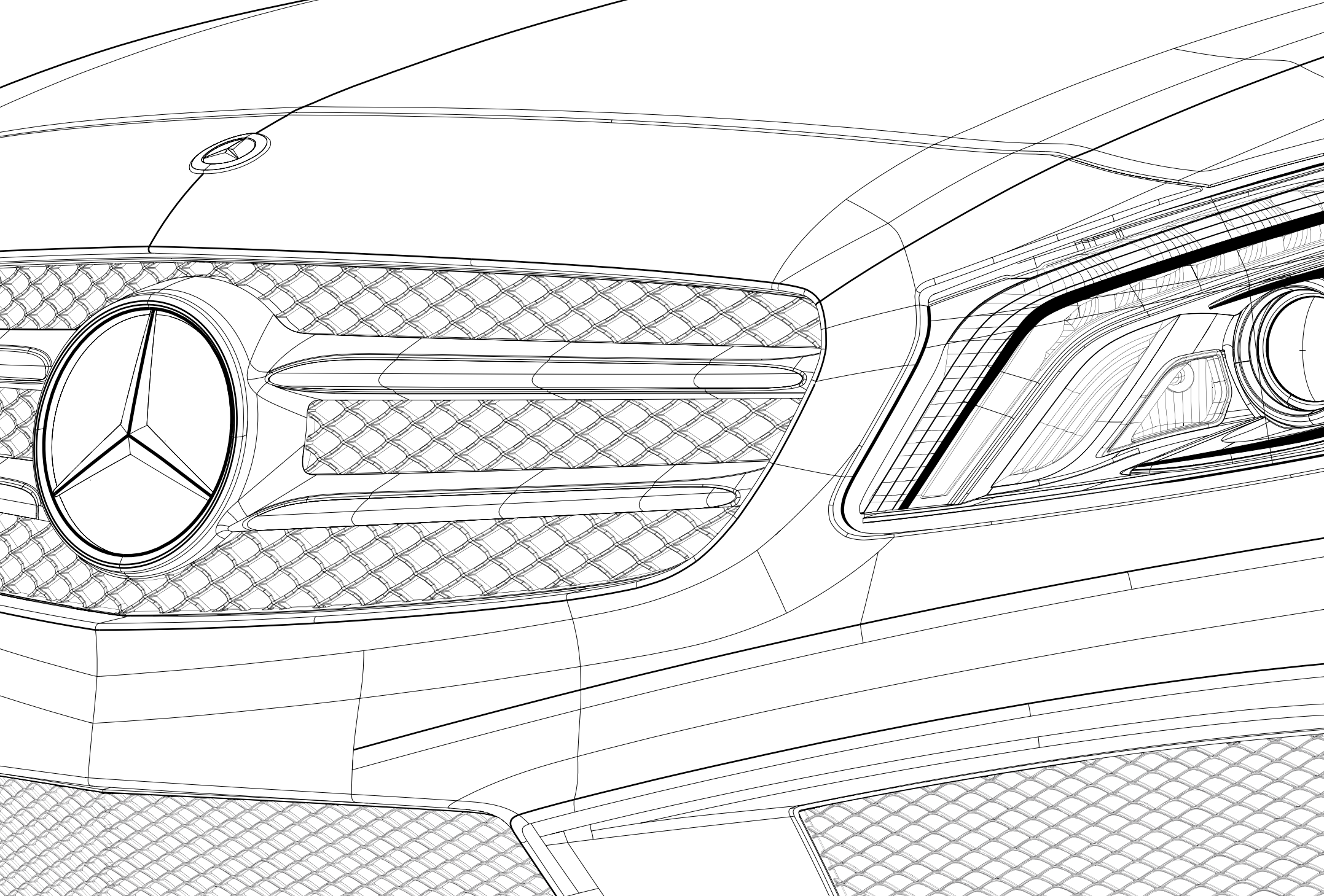

Diesel engines.

More economical, cleaner, more powerful: the A-Class also signals the launch of the latest Mercedes-Benz diesel technology. The engines are powerful and quiet. And they impress with their optimised emission and fuel-consumption figures.

4-cylinder in-line engines. The 4-cylinder diesel engines display hallmark Mercedes qualities: they boast a hefty torque and an immediate response, even at bottom-end revs. At the same time the diesel engines are modest when it comes to fuel consumption, are low on emissions and impress with their significantly improved quiet-running characteristics and their reduced vibrations. The

fourth-generation common-rail diesel technology includes an injection pressure increased to 1800 bar, optimised combustion chambers and precise solenoid valve injectors. Improved ignition pressure and a turbocharger with a variable nozzle turbine ensure a high torque in every engine speed range. Intelligently controlled ancillaries help to increase efficiency.

All the diesel engines have an ECO start/stop function that switches the engine off temporarily when the vehicle is stationary.

The 4-cylinder diesel engines are available with the following outputs:

- A 160 CDI with 66 kW (90 hp) and a maximum torque of 240 Nm
- A 180 CDI with 80 kW (109 hp) and a maximum torque of 260 Nm (also as A 180 CDI BlueEFFICIENCY Edition)
- A 200 CDI/A 200 CDI 4MATIC with 100 kW (136 hp) and a maximum torque of 300 Nm – already compliant with the Euro-6 emissions standard
- A 220 CDI/A 220 CDI 4MATIC with 125 kW (170 hp) and a maximum torque of 350 Nm – already compliant with the Euro-6 emissions standard

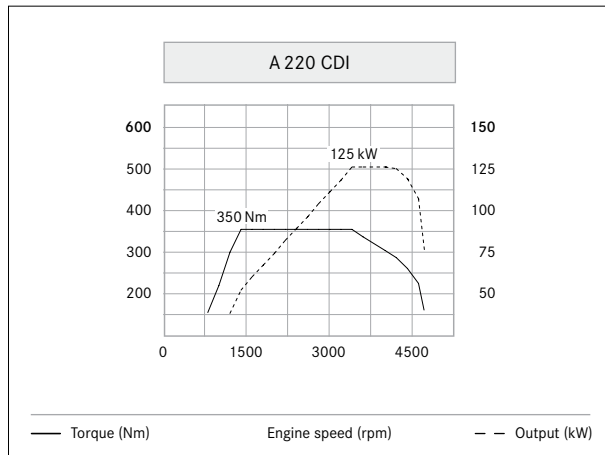

The A 220 CDI achieves its peak torque of 350 Nm at between just 1400 and 3400 rpm.



The 4-cylinder diesel engine in the A 200 CDI combines pulling power with low consumption and low emissions.

Petrol engines.

The petrol engines were developed with the aim of reducing fuel consumption and emissions without compromising on output and ride comfort.

4-cylinder in-line engines. The 4-cylinder powerplants with a displacement of 1.6 or 2.0 litres, direct petrol injection, variable valve timing and turbocharger offer outstanding torque and power, exemplary quiet operation plus appropriately low fuel consumption and emissions figures.



The 4-cylinder A 180 petrol engine boasts direct injection via piezo injectors and a turbocharger.

The high-pressure direct injection via precise piezo injectors and an enhanced combustion process allow virtually total combustion and thus higher efficiency, which means that the fuel can be used more efficiently. The variable valve control results in an optimum cylinder charge level and therefore consumption benefits, which also come courtesy of the lower weight, less internal friction plus ancillaries controlled as required. And last but not least,

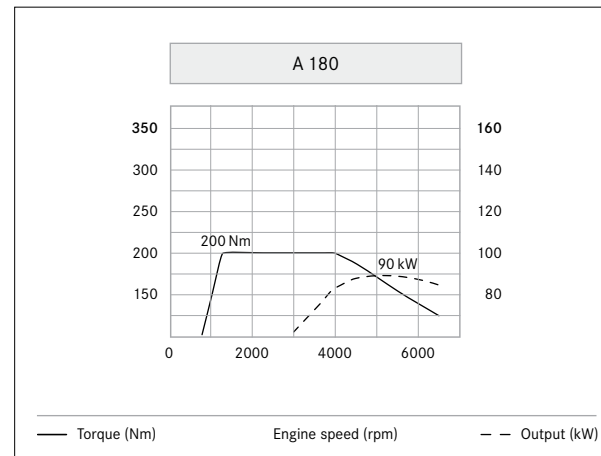

The A 180 delivers a peak torque of 200 Nm between 1250 and 4000 rpm.

the standard-specification ECO start/stop function further improves engine efficiency.

The 4-cylinder petrol engines are available with the following outputs:

- A 180 with 90 kW (122 hp) and a maximum torque of 200 Nm (also as A 180 BlueEFFICIENCY Edition)
- A 200 with 115 kW (156 hp) and a maximum torque of 250 Nm
- A 250 with 155 kW (211 hp) and a maximum torque of 350 Nm (also as A 250 Sport, A 250 4MATIC and A 250 Sport 4MATIC)
- A 45 AMG 4MATIC with 265 kW (360 hp) and a maximum torque of 450 Nm

All the petrol engines have low emissions and already meet the requirements of the Euro-6 emissions standard.

Transmissions.

Whether you choose the manual transmission or the optional dual clutch transmission 7G-DCT, whether you prefer an economical or sporty driving style – both transmissions for the A-Class are optimally matched to the engine. They set benchmarks where shift comfort, efficiency and weight optimisation are concerned.

6-speed manual transmission (standard for A 160 CDI, A 180 CDI, A 200 CDI, A 180 and A 200). The 6-speed manual transmission enables rapid gear changes thanks to its short shift travel. The standard-specification ECO start/stop function switches off the engine temporarily when the vehicle is standing at traffic lights and in jams, thus saving fuel. The standard-fit ECO display in the instrument cluster likewise promotes an efficient driving style. The A 180 CDI and A 180 BlueEFFICIENCY Edition models are equipped with an efficiency-optimised 6-speed manual transmission.

7-speed dual-clutch transmission 7G-DCT (option, standard for A 220 CDI, A 250, A 250 Sport and models with 4MATIC all-wheel-drive¹). With seven forward gears and one reverse gear the dual clutch transmission combines comfort, sportiness and economy. It comprises two sub-transmissions which each have their own clutch. One of these sub-transmissions supports the “even”

gears and the other the “odd” gears. On accelerating or braking, the next gear up or down is preselected in the unused sub-transmission. When changing gear there is then a switchover to the other sub-transmission. This means that the gear change takes place without any delay or loss of traction. Both the clutch actuation and the gear change occur fully automatically, allowing particularly smooth gear shifting without any interruption in traction. A switch on the centre console is used to set the preselectable modes “Economy”, “Sport” and “Manual”. The modes differ from one another in terms of shift characteristics and shift speed. In “Sport” mode, changing up a gear takes place at higher engine speeds than is the case in “Economy” mode, changing down a gear earlier. The “Manual” mode gives sporty drivers the option of changing gear manually using the steering-wheel gearshift paddles included in the package. Also integrated is the ECO start/stop function for reducing fuel consumption and the gearshift recommendation display in “Manual”

mode for efficient driving. In addition to this the currently engaged gear is always shown in the instrument cluster. An ergonomic DIRECT SELECT lever and the cruise control and SPEEDTRONIC functions are already included with 7G-DCT.

¹ AMG models with AMG SPEEDSHIFT DCT 7-speed sports transmission.

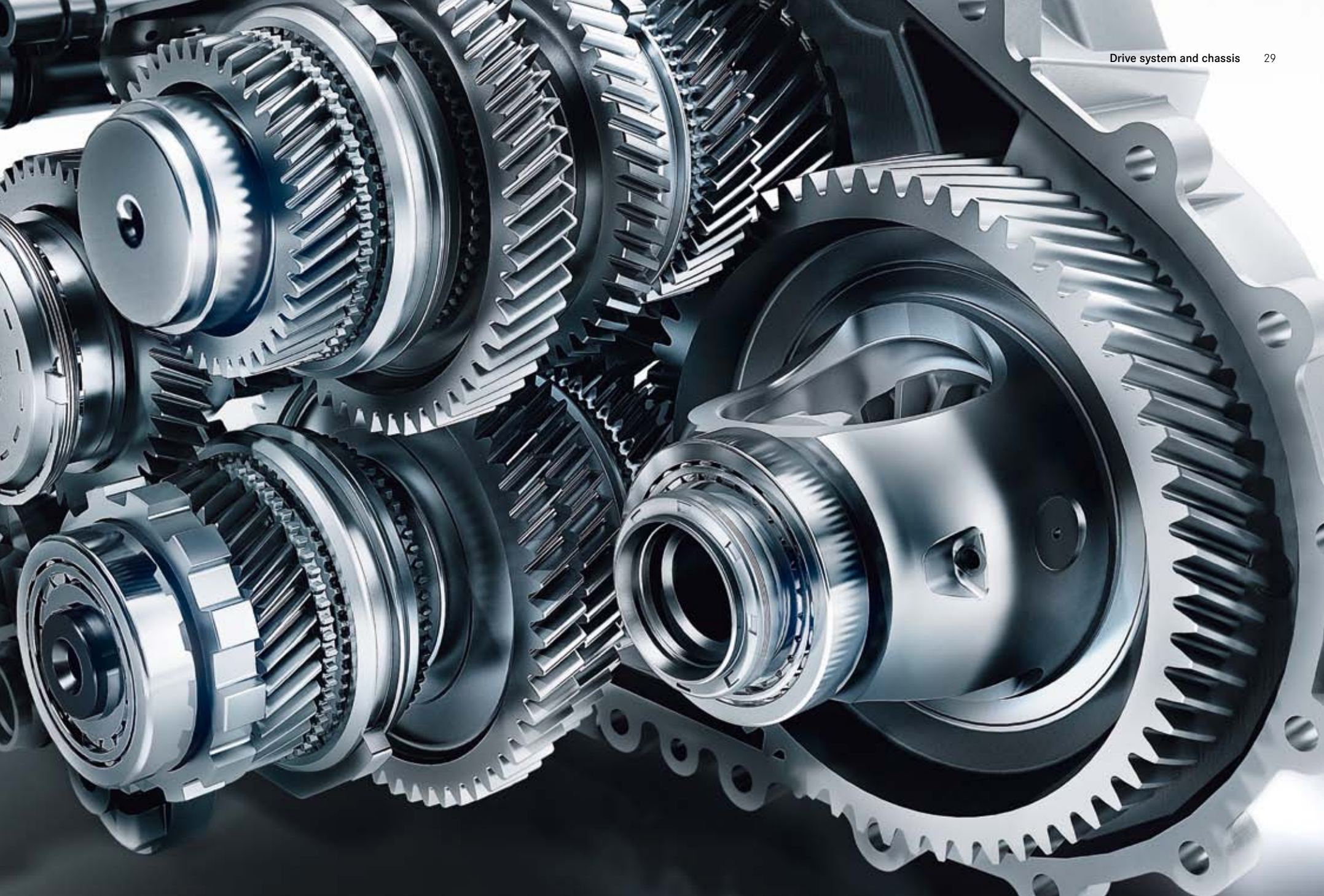

Chassis & suspension.

The driving characteristics of the A-Class can be tuned to individual requirements by specifying the optionally available combination of sports suspension and the Sports Direct-Steer system as an alternative to the standard-specification suspension and steering.

Suspension and steering. The suspension maximises driving stability and optimises ride comfort – thanks to intelligent weight distribution, a McPherson front axle and a four-link rear axle. The standard-fit rack-and-pinion steering with the STEER CONTROL assistance system enables precise handling in critical driving situations. The electromechanical power assistance is reduced as the car's speed increases.

Sports suspension (part of the optional AMG Line design and equipment line and the optional Dynamic Handling package). The sports suspension blends agility and handling safety with good road roar and tyre vibration characteristics. The springs and dampers have sportily taut tuning, while the level of the car is lowered by 15 mm – rolling movements are reduced and driving stability is increased. Lowered comfort suspension is available as an alternative.

Sports Direct-Steer system (part of the optional AMG Line design and equipment line and the optional Dynamic Handling package). The Sports Direct-Steer system enhances the comfort of speed-sensitive power steering with a ratio that varies depending on the steering wheel angle, ensuring that the steering movements produce an even more immediate response. It significantly reduces the steering effort required on tight bends or when parking, for instance. The straight-line stability is especially high at fast speeds and the feedback which the driver receives on the driving situation is very precise.

4MATIC. In its current version the permanent all-wheel drive system 4MATIC offers fully variable torque distribution between the front and rear axle. This facilitates sporty driving characteristics with optimum traction in different driving conditions – on snow, on ice or during dynamic manoeuvres, for example. The 4ETS dynamic handling control system additionally boosts driving safety and agility, particularly on surfaces offering varying grip or on slippery roads.

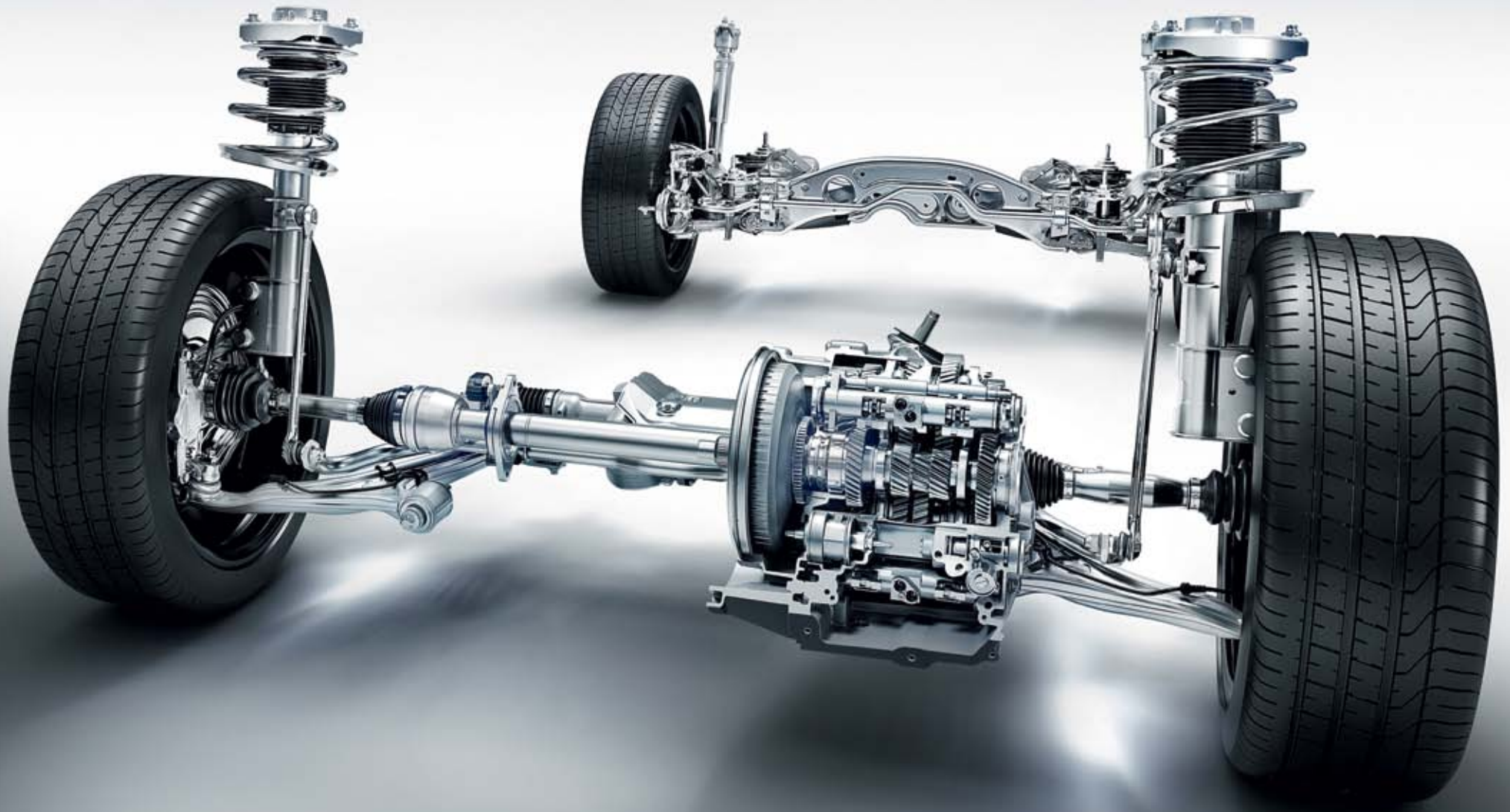

Integral safety concept.

We are driven by our vision of accident-free driving. With our integral safety concept we are coming closer to achieving this goal – this is a holistic approach which can increase safety in every situation.

As the inventor of the automobile we feel that we have a special responsibility for road safety. This is why we are the first car manufacturer to have developed an integral safety concept which seamlessly blends measures to enhance active and passive safety. The holistic approach is subdivided into four phases and offers safety solutions for every situation. It includes systems for safe driving which help to avoid risks by warning you and coming to your aid in good time. Our unique PRE-SAFE® is triggered in the event of danger and activates anticipatory measures for occupant protection. If a collision should occur despite these precautionary measures, further technologies ensure protection as needed. We have also borne in mind the time immediately following an accident and developed solutions which can help prevent worse and facilitate rapid help. A selection of these technologies for the “Safe driving”, “In the event of danger”, “In an accident” and “After an accident” phases is presented on the following pages.

Safe driving: ATTENTION ASSIST (standard). This drowsiness detection system is especially useful on long trips. At speeds of between 80 and 180 km/h, ATTENTION ASSIST warns the driver as soon as it detects signs of drowsiness. Sensors analyse driving behaviour and can detect deviations from a previously determined, individual driver profile.



If ATTENTION ASSIST detects signs of driver drowsiness it recommends taking a break.

Safe driving: COLLISION PREVENTION ASSIST (standard). At speeds of more than 7 km/h the system is able to detect when distances between the vehicle in which it is fitted and those in front or stationary obstacles are too short. If a hazard is detected the driver is given both visual and acoustic warnings. If the driver applies the brakes at the same time, Adaptive Brake Assist can provide the precise amount of braking power required for preventing an impending collision under ideal circumstances.



COLLISION PREVENTION ASSIST can recognise a safety distance that is too short and warn the driver.

Safe driving: ADAPTIVE BRAKE (standard). A dynamic handling control system with a modular structure. It offers additional safety and comfort functions alongside a base function such as the anti-lock braking system (ABS). The “dry braking” function can remove the film of water from the brake discs in wet conditions – the brake’s response time and therefore the stopping distance can be reduced. “Priming” ensures that the brake pads are placed against the brake discs as soon as the driver takes their foot off the accelerator pedal quickly. The time gained shortens the response time of the brakes. When moving off on an incline unintended rolling back is prevented during the space of time when the foot is moving from the brake pedal to the accelerator. If you briefly depress the brake pedal more firmly whilst the vehicle is stationary, the standard-specification HOLD function keeps the vehicle at a standstill, even if the driver takes their foot away from the brake pedal.

Safe driving: DISTRONIC PLUS adaptive cruise control (option). The adaptive cruise control uses short and long-range radar to maintain the desired safe distance to the vehicle in front. The system operates at between 0 and 200 km/h and is also helpful in city traffic or stop-and-go traffic as the sensor can operate in a range of between 0.2 and 200 metres. When a danger of a rear-end collision arises, COLLISION PREVENTION ASSIST PLUS – part of DISTRONIC PLUS – is able to initiate partial braking in

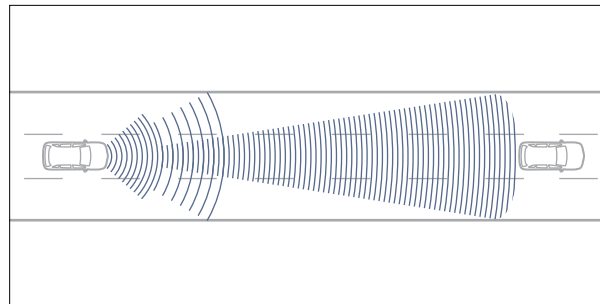

The DISTRONIC PLUS adaptive cruise control assists the driver by automatically keeping their vehicle at a safe distance from the vehicle in front.

order to avoid a collision or to mitigate the consequences. The DISTRONIC PLUS adaptive cruise control is only available in conjunction with the optional 7-speed dual clutch transmission 7G-DCT.

Safe driving: Lane Keeping Assist/Blind Spot Assist (option, both part of the optional Lane Tracking package). With the aid of the white lane markings, Lane Keeping Assist is able to detect a lane and through gentle steering-wheel vibrations it can warn the driver if they are in danger of leaving the lane unintentionally. Blind Spot Assist uses two radar sensors to monitor the area which can only be seen poorly by the driver directly alongside and behind the vehicle. If the assistance system detects the danger of an impending collision with another vehicle when changing lanes, the driver can be warned by both visual and acoustic signals if the car is travelling at 30 km/h or more.

Safe driving: Intelligent Light System (option). The system has the following functions: country mode, motorway mode, enhanced fog lamp function, active light function and cornering light function. The LED daytime running lamps integrated into the headlamps plus the LED tail lights enhance perceptual safety during the daytime.

In the event of danger: PRE-SAFE® system (option). The preventive occupant protection system PRE-SAFE® is able to recognise critical driving situations in advance and, if necessary, it can activate safety systems as a precaution to help reduce the risk of injury to occupants. This is based on PRE-SAFE® continuously monitoring sensor data from systems such as ESP® and BAS and identifying driving situations such as oversteer/understeer and emergency stops. If a critical driving situation is detected, in fractions of seconds the front seat belts are reversibly

tensioned and the side windows and optional sliding sunroof automatically closed so that the belts and airbags can deploy their full protective effect should an impact occur.

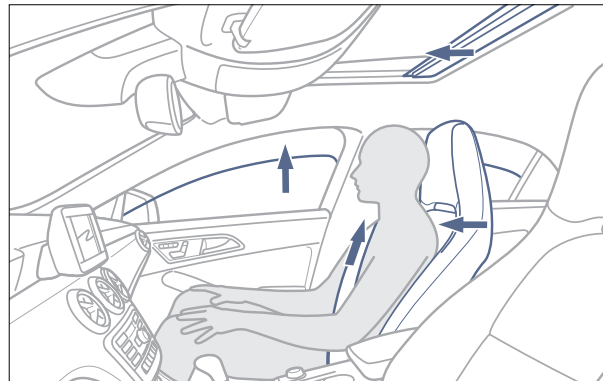

PRE-SAFE® can recognise critical driving situations and initiate preventive measures to protect the occupants.

In an accident: active bonnet (standard). It can reduce the risk of injury to pedestrians or cyclists if they are involved in a collision with the bonnet in a speed range between 25 and 55 km/h. To cushion the blow, the bonnet is raised 6 centimetres at the rear by pyrotechnic means.

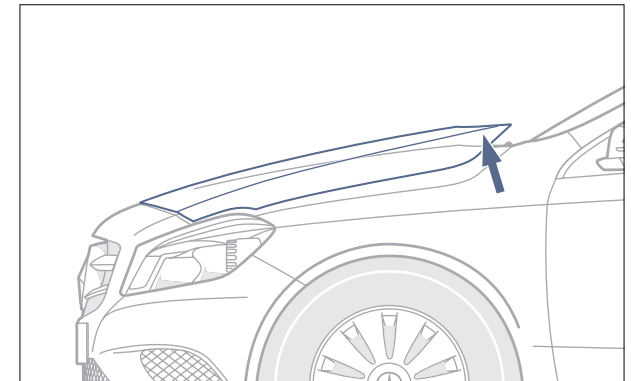

The active bonnet helps to reduce the risk of injury to pedestrians and cyclists in collisions.

In an accident: restraint systems (standard).

Mercedes-Benz ensures that the 3-point seat belts, belt tensioners, belt force limiters and airbags are all coordinated optimally to minimise any injuries. In addition to the high-strength bodyshell structure and the highly stable occupant cell, seven standard-fit airbags contribute towards

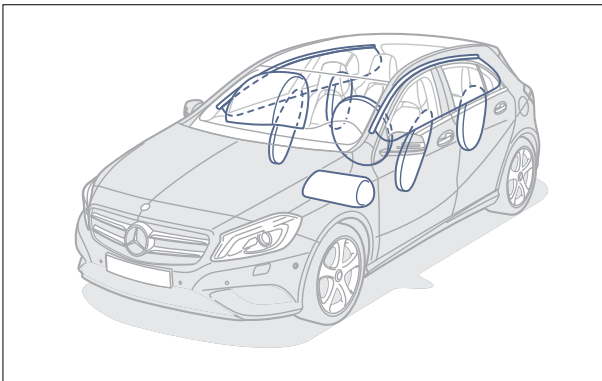

Standard equipment includes windowbags over both rows of seats, airbags and sidebags for the front-seat occupants as well as a driver kneebag.

optimum protection of the vehicle occupants: front airbags, which can be deployed in two stages, depending on the impact severity and accident characteristics, windowbags between the A- and C-pillars and sidebags for the driver and front passenger. The kneebag can further reduce the forces exerted on the driver during an accident. Sidebags are available on the left and right in the rear as an optional extra. If the crash sensors detect an accident, the seat belts are tensioned within a few milliseconds to secure the occupants in their seats. The belt force limiters, in turn, reduce the belt tension where appropriate in order to lessen the load on the thorax.

After an accident: Mercedes-Benz emergency call system¹ (part of COMAND Online). This system makes an emergency call automatically using a mobile phone which is on standby and connected to the vehicle as soon as the restraint system detects an accident. At the same time it communicates GPS positional data and other vehicle

information to the Mercedes-Benz emergency call centre. A voice connection is then established. The emergency call system can also be triggered manually.

Measures after an accident. In order to reduce consequential damage and, where necessary, to assist with the rescue of the occupants, Mercedes-Benz has developed further measures. These include the automatic engine cut-off or the activation of the hazard warning lamps and interior emergency illumination. The central locking also opens automatically and thus makes it easier to open the doors after an accident. Mercedes-Benz also provides multilingual rescue guidelines which emergency services can download online worldwide at www.mercedes-benz.de/rettungsleitfaden. As you can see, Mercedes-Benz offers well thought-out safety whatever the situation.

¹ Available over the entire operating life of the vehicle in 19 European countries.

Multimedia systems.

The A-Class offers a full range of entertainment systems, from the Audio 5 USB and the optional Audio 20 CD system with Becker® MAP PILOT to the optional COMAND Online multimedia system.



COMAND Online facilitates user-friendly operation of the main information and communication functions via a single high-resolution display with a diagonal of 17.8 cm.

COMAND Online (option). The multimedia system with hard-disc navigation system and a 17.8 cm high-resolution colour display with topographical map display. Further functions: display of BMP and PNG image formats, Music Register with a 10 GB hard disc, Cover Flow function and a DVD drive for video and audio DVDs, CDs and MP3 files. Via an internet-capable mobile phone the online browser enables access to the internet and to mobile services from Mercedes-Benz. Live Traffic Information¹ enables the receipt of current and detailed traffic information in real time, for example. Data transmission is via a communications module which provides the internet connection thanks to an integral SIM card, including data roaming. A USB slot and a slot for SD memory cards plus a Bluetooth® interface are included. The system is controlled via an intuitively operated Controller and the buttons in the multifunction steering wheel. The LINGUATRONIC enables the COMAND Online to be operated via voice entry.

¹ 3 years of free use, available in 12 countries.

Drive kit Plus for the iPhone® (option). With the drive kit Plus for the iPhone®, your iPhone® 4/4s or iPhone® 5/5s/5c is comprehensively integrated in the A-Class. The accompanying Digital DriveStyle app is available free of charge from the iTunes® Store. The app allows you to use Audio 20 CD or COMAND Online to show content from your iPhone® on the display and to navigate this content reliably and conveniently by means of the Controller. This setup gives you access to features such as the advanced navigation solution from Garmin® with internet-based real-time traffic information, Google® online POI



With the drive kit Plus for the iPhone® and the Digital DriveStyle app, the smartphone is extensively integrated in the A-Class.

search, Google® Streetview and 3D map display. The Siri™ voice recognition software allows audio-based communication with your iPhone®, or it can perform commands that otherwise require manual input.

Audio 20 CD (option). The multimedia system boasts a TFT display with a 14.7 cm screen diagonal. Thanks to its integral CD drive both MP3 and WMA/AAC files can be played. As an option a 6-disc CD changer can be added to the system. Audio 20 CD can be conveniently operated via the multifunction steering wheel and the Controller in



The functions provided by the Becker® MAP PILOT are indicated on the Audio 20 CD display and the multifunction display in the instrument cluster.

the centre console, and it includes an integral telephone keypad, a Bluetooth® interface with a hands-free function and a USB socket in the stowage compartment on the centre console. Six loudspeakers provide an outstanding listening experience.

Becker® MAP PILOT (option). Fully integral, the Becker® MAP PILOT with 3D map navigation can be operated using voice entry, via the Controller or via the multifunction steering wheel. It can be individualised in next to no time by downloading current map data and additional functions.

Harman Kardon® Logic 7® surround sound system (option). With twelve loudspeakers, including a woofer and a 9-channel DSP amplifier, in conjunction with COMAND Online the 450-watt Dolby Digital 5.1 system offers an exquisite listening experience. The surround playback can be individually tuned to the entire passenger compartment, the front compartment, the centre area or the rear compartment.

Assistance systems.

Alongside numerous safety systems, various convenience assistance systems are available for the A-Class, too. They can provide timely warnings of potentially critical situations and so help the driver to avoid dangers.

Reversing camera (option, in conjunction with Audio 20 CD or COMAND Online). The reversing camera with a wide-angle lens and guide lines switches on when reverse gear is engaged and provides additional support for the driver by showing on the screen what is in the area directly behind the vehicle.

Active Parking Assist, including PARKTRONIC (option). With Active Parking Assist on board, the vehicle looks for a suitable parking space by itself at a speed of up to 35 km/h. As soon as the driver confirms a suggested parking space and engages reverse gear, Active Parking

Assist automatically parks the car at the press of a button. The driver then only needs to use the gearshift, the accelerator and brake pedal. Active Parking Assist deals with the steering on its own. The system works extremely precisely: for automatic parking, the parking space only has to be around one metre longer than the vehicle.

Speed Limit Assist (part of the optional COMAND Online system). Speed Limit Assist uses a windscreen-mounted camera and navigation data to detect speed-limit signs and then display them as symbols on the instrument cluster. They remain displayed there until the speed restriction is

lifted or changed. To this end, the camera monitors the area in front of the car on a permanent basis. It can filter out round traffic signs, be they speed-limit signs at the side of the road or on a gantry above the road. Speed Limit Assist is especially helpful on routes with variable speed limits or road works.



During parking, the COMAND Online central display shows the area behind the car.



The display in the instrument cluster gives you a clear picture of what is happening during the current parking manoeuvre.



The information from Speed Limit Assist is shown both in the instrument cluster and in the COMAND Online central display.

Light and climate control.

The optionally available Light and Sight package underlines the safety standards in the A-Class and stylishly showcases the interior in darkness. The automatic climate control THERMOTRONIC contributes towards a pleasant interior climate.

Light and Sight package (option). This package enhances safety and improves the driver's perception of the traffic – in particular during darkness or in poor weather conditions – with features such as windscreen wipers fitted with a rain sensor and an enlarged washer fluid reservoir, exit and warning lamps for the driver's and front-passenger door, plus a warning and background lamp for the tailgate. Quite apart from the safety aspects, the integral ambient lighting in the door shells and door pulls lends the interior design of the A-Class an exclusive touch. In conjunction with sports seats the opening between the head restraint and the seat backrest is stylishly illumi-

nated. This overall impression is enhanced by sun visors with an illuminated vanity mirror, an illuminated interior mirror, footwell lighting for the driver and front passenger and in the rear, illuminated door sill panels at the front, separately controllable reading lamps on both the left- and right-hand side in the rear – and by a downlighter for the rear compartment.

THERMOTRONIC (option). The automatic climate control THERMOTRONIC has separate temperature controls for each side of the interior, allowing the driver and front passenger to travel in comfort at the temperature of their

choice. At the touch of a button the 2-zone system works fully automatically with an integral particulate matter activated charcoal filter to prevent dust, pollen and odours from entering the interior. At the back of the centre console there are also two air outlets for the rear compartment. THERMOTRONIC keeps the desired temperature constant and also takes exterior factors such as sunlight, air quality and humidity into account by means of sensors. This means that there is always a pleasant climate in the A-Class.



The optionally available Light and Sight package highlights the interior design to practical and stylish effect.



The optional automatic climate control THERMOTRONIC ensures pleasant interior temperatures.

Seats.

The seats are offered in three different variants, meeting individual requirements regarding ergonomics, seating comfort and safety.

The standard-fit seats have high backrests, offer good lateral support and feature black fabric upholstery.

The optionally available luxury seats with three horizontal fluting elements in the extended shoulder area can be ordered either in fabric or ARTICO man-made leather in the colours black or crystal grey. The optional high-quality sports seats with integral head restraints are part of all the design and equipment lines plus the Exclusive packages. They ensure high levels of seating comfort. There are several types of upholstery to choose from, including seat



The comfortable front seats in the A-Class impress with their ergonomics and wide-ranging adjustment options.

covers in ARTICO man-made leather/fabric plus in ARTICO man-made leather/DINAMICA microfibre or fine leather. Depending on the equipment, drivers can select from the colours black, crystal grey and nut brown.

Seat Comfort package (option). The seats in the Seat Comfort package are characterised by their specific seat cushion design featuring an accentuated shoulder area. They offer the driver and front passenger special comfort on long journeys. The package comprises height adjustment plus seat cushion inclination adjustment for both front



The A-Class offers high levels of seating comfort for the rear passengers, too.

seats. Numerous possibilities for ergonomic individualisation and adjustment to the preferred seat position help to further enhance seating comfort.

4-way lumbar support for the driver and front passenger (option). The backrest curvature can be individually adjusted to meet the needs of the driver and front passenger. Two air cushions are integrated in the backrests of both front seats. Via two control valves they can be inflated or deflated as required to provide precisely measured lumbar support. The height of the air cushions is also adjustable.

Electric seat adjustment with Memory function (option). Electrically adjustable driver's and front passenger seats are available as an option. The Memory function can save three individual settings for the position of the seats and the exterior mirrors, and they can be called up again at any time.

Roof and space.

The A-Class is impressively spacious for a vehicle in the compact class. The panoramic sliding sunroof lets lots of light in and ensures an even greater feeling of spaciousness. The load compartment offers plenty of room for luggage.

Panoramic sliding sunroof (option). The panoramic sliding sunroof is an electrically operated glass sliding roof which slides over the exterior of the vehicle roof. The large, transparent surface offers a generous view and lets lots of light into the interior, creating a particularly light and friendly ambience. A roller blind operated by electric motor shields the occupants from bright sunlight. The wind deflectors with a net structure minimises the noise level when travelling with the roof open. If the optional Light and Sight package is specified, the roof closes automatically when it starts to rain.



Thanks to the incident light let in through panoramic sliding sunroof, the A-Class appears even lighter and more spacious.

Load compartment. If required the rear seat backrests can be folded with a 1/3:2/3 split, giving a boot capacity of up to 1157 litres with a 1.24-metre-long virtually flat load compartment area. When using the A-Class as a 5-seater the boot capacity is 341 litres.



The interior can be transformed into a generous load area in just a few simple steps.

Stowage Space package (option). The Stowage Space package provides a variety of organisational aids for placing and stowing various items. The package includes a spectacles compartment in the overhead control panel, a stowage box under the front seats, luggage nets on the driver's and front passenger seat backrests, in the front-passenger footwell and on the side of the boot as well as beneath the parcel shelf plus a practical 12 V socket in the boot.



The practical Stowage Space package provides plenty of space for storing various items in the A-Class.

Sports models A 250 Sport and A 250 Sport 4MATIC – engineered by AMG.

The sports models impress with their expressive design and promise added dynamism thanks to AMG sports suspension that has been developed in-house and features a specific front axle.



An exceptional character and powerful dynamics, combined in the A 250 Sport.

For special driving dynamics the A-Class is available as the sports model A 250 Sport and as the A 250 Sport 4MATIC all-wheel-drive variant. Both models have AMG sports suspension – featuring a specific front axle and sporty engine and transmission tuning – developed by the specialists at Mercedes-AMG. The further equipment is based on the AMG Line design and equipment line, supplemented by other exterior and interior features. These include the striking diamond radiator grille and the characteristic red trim on the AMG front and rear apron plus the red highlight rings in the headlamps. The athletic look is enhanced by the 5-spoke AMG light-alloy wheels which are painted black with a high-sheen finish and shod with 235/40 R 18 tyres. The perforated brake discs at the front, the red brake callipers at the front and rear plus the sporty engine sound lend the sports models an air of pure dynamism. The two-pipe exhaust system with oval tailpipe trim in polished stainless steel and the “SPORT” badges on the front wings complete the look.

The sports models impress with characteristic features in the interior, too. This is due in the main to the sports seats with upholstery in ARTICO man-made leather/DINAMICA microfibre with red contrasting topstitching plus the matching red 3-point seat belts. AMG performance seats are optionally available. Further hallmark highlights in the sports models include the red rings on the air outlets and in the red needles on the sporty instrument cluster. The 3-spoke multifunction steering wheel is finished in leather and has red contrasting topstitching, as do the armrests in the centre console and the doors. The door centre panels are trimmed in black DINAMICA microfibre, and the trim sports a carbon fibre look. The dynamic impression is accentuated by the sports pedals in brushed stainless steel with rubber studs and front door sill panels in aluminium. In addition to this, cord floor mats with black piping, red contrasting topstitching and "SPORT" lettering are also part of the sports models' host of equipment.



The sports seats in ARTICO man-made leather/DINAMICA microfibre upholstery with red contrasting topstitching.

A 45 AMG 4MATIC exterior.

Visibly more powerful: the exterior of the A 45 AMG 4MATIC clearly shows that its roots lie in Affalterbach. Examples of these cues are the AMG light-alloy wheels plus the AMG sports exhaust system, and above all the front and rear apron featuring an AMG design. → www.mercedes-amg.com

Sportiness as far as the eye can see: the AMG front apron with black flics and the AMG radiator grille with a twin louvre move impressively into view. Elements painted in matt titanium grey in the front and rear apron plus side sill panels lend the dynamic design of the vehicle an addi-

tional athletic touch. An equally powerful impression is made by the AMG 5-twin-spoke light-alloy wheels painted in titanium grey with a high-sheen finish. With its uncompromisingly sporty character it has clearly earned the “TURBO AMG” lettering on the wings. As most people

only ever see it from behind, the A 45 AMG is impressive there, too – thanks to the AMG sports exhaust system with its specific AMG tailpipe trim design.



The two-pipe AMG sports exhaust system and AMG-design rear apron.



The “TURBO AMG” lettering marks it out as a truly top athlete.



Optional: AMG wheel bolt cover and red-painted brake callipers.



A 45 AMG 4MATIC interior.

An athlete through and through on the inside, too: the interior of the A 45 AMG 4MATIC is more of a cockpit than a driver's compartment. This is thanks to the sports seats with their red topstitching plus red belts – but also the AMG-specific design of the instrument cluster.



The AMG instrument cluster and the air nozzles with red surrounds inject sportiness into the cockpit.

Enter the world of motorsport in fitting style – through the driver's door. AMG door sill panels announce the sporty nature of the interior. The AMG DRIVE UNIT offers direct access to the transmission modes. Thanks to the AMG instrument cluster with its AMG main menu, including Racetimer and the AMG start-up indicator, you always have a good view of everything – and with the 3-spoke sports steering wheel with the flattened bottom section and shift paddles you have a good grip on everything, too. Sports seats in ARTICO man-made leather/DINAMICA microfibre with red topstitching provide optimum support, even when taking sharp bends. Red seat belts and rings for the ventilation outlets complete the sporty interior.



A 45 AMG 4MATIC technology.

For AMG, sport goes hand-in-hand with record-breaking: The AMG 2.0-litre turbo-charged engine is the world's most powerful series production 4-cylinder engine. Further AMG technology helps to transfer that power to the road in a most impressive manner.

AMG 2.0-litre 4-cylinder turbocharged engine. A true power pack: with 450 Nm and 265 kW (360 hp) the 2-litre turbocharged unit is the world's most powerful series-produced 4-cylinder engine. It achieves 181 hp per litre of displacement - made possible by highly precise piezo



The centre of power: the AMG 2.0-litre 4-cylinder turbocharged engine.

injectors, a twin-scroll turbocharger, forged pistons and crankshaft plus the experience gained from 45 years of AMG motorsport. At the same time its combined consumption in the A 45 AMG is just 6.9 litres per 100 km - for these output values an unparalleled result - thanks in part to the ECO start/stop function. The high-performance engine is built entirely by hand based on the traditional AMG "one man, one engine" philosophy - which is clearly evident on the AMG engine badge bearing the signature of the AMG technician responsible.

AMG high-performance braking system. The fastest one standing wins. This is why the A 45 AMG boasts internally ventilated and perforated brake discs, which release more braking energy. The front discs measure an impressive 350 x 32 mm and have a 4-piston fixed calliper, while the rear axle has 330 x 22 mm discs with a 1-piston floating calliper that brings the vehicle to a standstill faster. Everything that is needed to keep the vehicle's impressive power under control at all times.

AMG SPEEDSHIFT DCT 7-speed sports transmission.

The incredible power of the AMG engine is optimally transformed into propulsion by the sports transmission. It offers rapid gear shifting without interruptions to tractive power, with shift times like those in the SLS AMG GT, plus three differently tuned transmission modes (C, S and M). A Racestart function, partial cylinder shut-off when upshifting and the double-declutching function when downshifting create a racing feel and a motorsport-inspired sound experience.

AMG performance 4MATIC all-wheel drive system.

450 Nm of torque are delivered precisely where needed in the A 45 AMG: to the road. This happens courtesy of a fully variable, performance-oriented all-wheel-drive system, which – with its AMG-specific electrohydraulic control – ensures optimum traction and thus transforms the unfettered force into dynamic propulsion.

AMG speed-sensitive sports steering and AMG sports suspension. In combination with the AMG sports suspension and the front and rear axles specially developed for the A 45 AMG, the electromechanical AMG speed-sensitive sports steering offers high steering precision plus agile handling – for sporty driving pleasure.



Autonomous steering knuckles at the front with AMG-specific elastokinematics increase dynamism thanks to stiffer axle bearings.

AMG Performance Studio.

An incomparable AMG vehicle becomes a one-off specimen in the AMG Performance Studio. Lend your vehicle a totally individual style which underlines its dynamic and sporty character. Precisely how you want to drive the A 45 AMG 4MATIC is entirely up to you.



The AMG performance seats in conjunction with the AMG Exclusive package.

In the AMG Performance Studio your A 45 AMG is given even more personality. You can have the vehicle tuned more tautly with a performance suspension, give it an even more dominant appearance with the AMG Exterior Carbon-Fibre package or the AMG Night package, or you can have the vehicle sound even more powerful with the AMG performance exhaust system, including specific tailpipe trim. You can fit a number of other eye-catching features in the form of brake callipers painted red and two exclusive light-alloy wheel designs. On request you can increase the top speed to 270 km/h with the Driver's Package. And exclusive upgrades are available for the interior, too: the AMG performance seats, for instance, with increased lateral support, an AMG performance steering wheel, including the E-SELECT lever, plus the master key with the AMG emblem. The AMG Performance Studio leaves virtually nothing to be desired – right through to a one-off specimen.





Standard equipment.

The A-Class offers hallmark Mercedes comfort as standard.

Sportiness coupled with quality: the A-Class impresses on the exterior with remarkable ideas and painstaking attention to detail. The ex-factory specification includes steel wheels with 10-hole wheel trim and 195/65 R 15 tyres (205/55 R 16 for the A 200 CDI and A 200) plus a compact rear bumper in the vehicle colour with a black-grained diffuser insert. The latest-generation assistance systems, such as COLLISION PREVENTION ASSIST and ATTENTION ASSIST, are already included in the standard specification.







The A-Class impresses with its outstanding functionality. Standard-fit equipment includes the air conditioning and the Audio 5 USB radio with a twin tuner, three-line display and USB interface. The interior scores points with a 3-spoke multifunction steering wheel with 12 function buttons, the multifunction display in the instrument cluster and a hinge-type stowage compartment in the armrest for the driver and front passenger. The standard trim features a honeycomb look. The seats and door centre panels are covered in black fabric. Optional extras include luxury seats in a choice of further upholstery and colours.

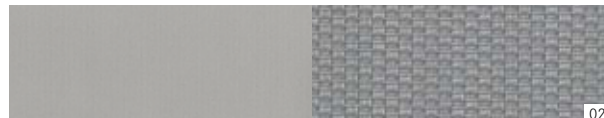
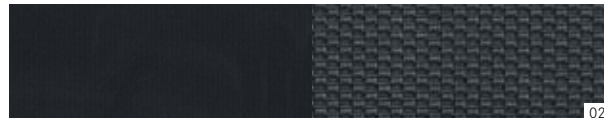
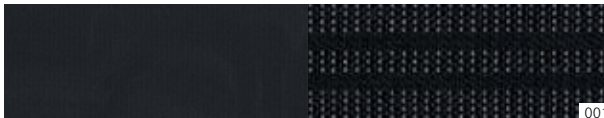

Standard seat model

001 black (fabric)

Luxury seat model (option)

021 black (fabric)

028 crystal grey (fabric)

101 black (ARTICO man-made leather)

108 crystal grey (ARTICO man-made leather)

Trim

honeycomb look

The illustrations show the optionally available drive kit for the iPhone®.

Style design and equipment line.

The Style design and equipment line lends the A-Class a confident air.

The Style design and equipment line includes 10-spoke light-alloy wheels with 205/55 R 16 tyres. A radiator grille with two louvres in the vehicle colour and chrome trim ensures a youthful and unique vehicle character.









The optional Style design and equipment line adds individual highlights. The interior boasts sports seats in fabric/ARTICO man-made leather with contrasting topstitching, either in black or in black/white, an instrument cluster featuring a colour display, black roof liner (grey roof liner is optional) plus black matrix-look trim and ventilation outlets with surfaces in silver chrome.



451



101

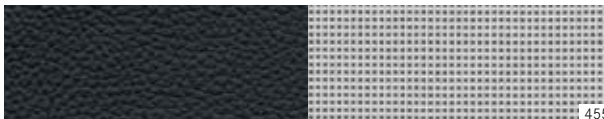

455



108



Sports seat model

- 451 black (ARTICO man-made leather/fabric)
- 455 black/white (ARTICO man-made leather/fabric)

Luxury seat model

- 101 black (ARTICO man-made leather)
- 108 crystal grey (ARTICO man-made leather)

Trim

- black matrix look
-

Urban design and equipment line.

The Urban design and equipment line makes the A-Class even sportier.

The optionally available Urban design and equipment line showcases the A-Class in a sporty, expressive way and impresses with its 5-twin-spoke light-alloy wheels with 225/45 R 17 tyres, a radiator grille featuring a silver-coloured twin louvre with chrome trim and a two-pipe exhaust system with chrome-look tailpipe trim.









The interior of the Urban design and equipment line displays enhanced sportiness with its sporty instrument cluster featuring a colour display, and sports seats in black or crystal grey, checked-pattern trim, a 3-spoke multifunction steering wheel with perforated leather and contrasting topstitching plus door centre panels and armrests which feature contrasting topstitching throughout. In addition to this, luxury seats with ARTICO upholstery can also be selected in black or crystal grey.



361



101



368



108



Sports seat model

- 361 black (ARTICO man-made leather/fabric)
 - 368 crystal grey (ARTICO man-made leather/fabric)
-

Luxury seat model

- 101 black (ARTICO man-made leather)
 - 108 crystal grey (ARTICO man-made leather)
-

Trim

- black checked pattern
 - crystal grey checked pattern
-

AMG Line design and equipment line.

The optional AMG Line design and equipment line lends the A-Class a powerful appearance.

Dynamism even at a standstill – visible signs of this are the AMG bodystyling, consisting of a front and rear apron plus side skirts, the silver-coloured radiator grille with two louvres and chrome inserts plus the two-pipe exhaust system with oval tailpipe trim in polished stainless steel. The exclusive diamond radiator grille is available as an option. Better handling and more fun at the wheel come courtesy of a lowered sports suspension and the Sports Direct-Steer system. The equipment is rounded off by AMG multi-spoke light-alloy wheels painted titanium grey with a high-sheen finish and shod with 225/40 R 18 tyres, plus perforated front brake discs and also front brake callipers with Mercedes-Benz lettering.









Characteristic features of the AMG Line design and equipment line's interior include sports seats in ARTICO man-made leather/DINAMICA microfibre with red contrasting topstitching, door centre panels in black DINAMICA microfibre and black roof liner. There is a 3-spoke multifunction sports steering wheel – with a flattened bottom section – in leather with red contrasting topstitching and perforation in the grip area, a sports instrument cluster with red needles and a colour display, carbon-fibre-look trim and AMG floor mats in cord with black piping and red contrasting topstitching. The hallmark red contrasting topstitching also appears on the leather shift lever and the armrests in the centre console and the doors. The crowning glory? The sports pedals in brushed stainless steel with rubber studs and the front door sill panels in aluminium.

The illustration on the right shows the extended AMG Exclusive package, which is based on the AMG Line design and equipment line.

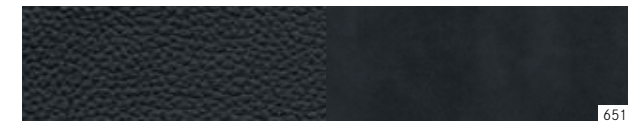

Sports seat model

651 black (ARTICO man-made leather/DINAMICA microfibre)

Trim

carbon fibre look



Night package.

Extravagant design ideas and special standards come together in the optionally available Night package. It comprises a high-gloss black radiator grille featuring a 2-louvre look with chrome trim, black exterior mirrors, a waistline trim strip in high-gloss black, 5-twin-spoke light-alloy wheels painted black with a high-sheen finish and 225/40 R 18 tyres plus heat-insulating dark-tinted glass for the rear windscreen and rear side windows. The Night package is designed as a purely exterior package for further individualisation, and is based on one of the three design and equipment lines Style, Urban or AMG Line. In conjunction with the AMG Line design and equipment line the Night package comprises AMG 5-twin-spoke light-alloy wheels painted black with a high-sheen finish and 225/40 R 18 tyres.



Exclusive package and AMG Exclusive package.



The optional Exclusive package meets the requirements of those looking for a particularly high-quality interior at luxury-segment level. It beguiles with its hallmark Mercedes luxury such as heated sports seats with a 4-way lumbar support for the driver and front passenger, plus black, crystal grey or nut brown leather upholstery. The steering wheel and selector lever are also trimmed with leather, while the door centre panels, the armrest and the dashboard are colour-coordinated with them and trimmed in ARTICO man-made leather. Floor mats in cord and front door sill panels in aluminium round off the appointments.

Based on the AMG Line design and equipment line, an extended AMG Exclusive package featuring two-tone upholstery in RED CUT black leather with red contrasting topstitching is available (please see the illustration on page 67).



801



811



808

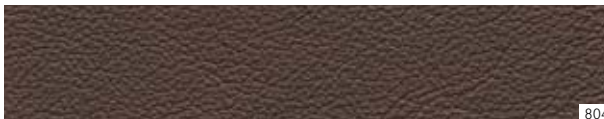

804



Exclusive package

Sports seat model

- 801 black (leather)
 - 808 crystal grey (leather)
 - 804 nut brown (leather)
-

Trim

- black (leather look)
 - crystal grey (leather look)
 - nut brown (leather look)
-

AMG Exclusive package

Sports seat model

- 811 RED CUT black (leather)
-

Trim

- carbon fibre look
-

Standard equipment | Selection.



3-spoke multifunction steering wheel with 12 function buttons.



Audio 5 USB.



Air conditioning.



Armrest with stowage compartment.



Power windows, 4.



Automatic headlamp activation.

Optional extras | Selection.



Bi-xenon headlamps.



Panoramic sliding sunroof.



Diamond radiator grille.



Illuminated door sill panels in the Light and Sight package.



Audio 20 CD with Becker® MAP PILOT.



THERMOTRONIC automatic climate control.

Wheels.



Steel wheels with 10-hole wheel trim, with 195/65 R 15 tyres (standard for A 160 CDI, A 180 CDI and A 180, Code R00).



Steel wheels with 10-hole wheel trim, with 205/55 R 16 tyres (standard for A 200 CDI and A 200, Code 643).



10-spoke light-alloy wheels with 205/55 R 16 tyres (standard in conjunction with Style, Code 55R).



5-twin-spoke light-alloy wheels painted matt black with a high-shine finish, with 205/55 R 16 tyres (option, Code R78).



10-spoke light-alloy wheels with 225/45 R 17 tyres (standard for A 220 CDI, A 250 and A 250 4MATIC, Code R43).



5-twin-spoke light-alloy wheels with 225/45 R 17 tyres (standard in conjunction with Urban, Code R11).



5-twin-spoke light-alloy wheels painted tremolite grey, with 225/45 R 17 tyres (option, Code 44R).



10-spoke light-alloy wheels with 205/50 R 17 tyres (optional winter wheels, Code 25R).



5-twin-spoke light-alloy wheels painted himalayas grey with a high-sheen finish, with 225/45 R 17 tyres (option, Code R48).



AMG 5-twin-spoke light-alloy wheels painted titanium grey with a high-sheen finish, with 225/40 R 18 tyres (option, Code 794).



AMG multi-spoke light-alloy wheels painted black with high-sheen rim flange, with 225/40 R 18 tyres (option, Code 646).



AMG 5-spoke light-alloy wheels painted black with a high-sheen finish, with 235/40 R 18 tyres (standard for A 250 Sport and A 250 Sport 4MATIC, Code 774).



5-twin-spoke light-alloy wheels painted black with a high-sheen finish, with 225/40 R 18 tyres (standard for Night package with Style or Urban, option, Code R38).



5-twin-spoke light-alloy wheels painted matt black with a high-sheen finish, with 225/40 R 18 tyres (option, Code R10).



AMG multi-spoke light-alloy wheels painted titanium grey with a high-sheen finish, with 225/40 R 18 tyres (standard in conjunction with AMG Line, Code 791).



AMG 5-twin-spoke light-alloy wheels painted black with a high-sheen finish, with 225/40 R 18 tyres (standard for Night package in conjunction with AMG Line, option, Code 781).

Genuine accessories.

Practical, versatile, progressive – there's not much the A-Class can't do. And there are always the genuine accessories from Mercedes-Benz.

→ www.mercedes-benz-accessories.com



Folding rear-mounted cycle rack for trailer couplings.

As if the A-Class didn't already make you mobile enough, the rear-mounted cycle rack gives you even more freedom as it can be used to carry two or three bikes with ease, even if the bikes themselves are quite heavy: each cycle rail has a payload of 30 kg, so most e-bikes can be transported with no problem at all. There is no problem opening the boot either: access to luggage is still possible thanks to an ingenious roller mechanism. When not in use, the rack folds easily and can be stowed in the boot, for example.

A further practical feature is the 400 roof box. It has an impressive capacity of around 400 litres, can take loads of up to 75 kg and has handles on both sides for easier handling. To make optimum use of the stowage space in the roof box, items such as a suitably sized three-bag luggage set or a ski bag for a maximum of two pairs of skis can be ordered.

And we can top this for the more sporty drivers in the form of a dynamic roof spoiler and a rear apron trim with a diffuser look. This also lends the A-Class a racy touch in visual terms.

See our range of genuine accessories for yourself – just take a look at our brochure or pay a visit to your authorised Mercedes-Benz dealer.



Practical, aerodynamic, elegant: the roof box offers much more than just stowage space.



More than simply a star. A whole universe.

The range of **services from Mercedes-Benz**. Every Mercedes brings with it as a standard feature a reassuring feeling of safety on the road. But if you ever do need help, we're here for you around the clock. You can reach us from anywhere in Europe on the toll-free number 00800 1 777 7777¹ (or alternatively direct through Mercedes-Benz Contact²).

Ensuring that you can keep moving in the event of a technical breakdown, accident, vandalism or even misfuelling, the **Mercedes-Benz mobility package Mobilo**³ is included as part of the standard specification. It covers the cost of local assistance, for example for towing your car away or for a replacement vehicle – and will do so in more than 40 countries across Europe for up to 30 years³. Furthermore, for the first four years following initial registration of the vehicle, Mobilo offers special mobility services in the case of workshop visits involving warranty or goodwill situations.

Avoid unexpected workshop costs⁴: a **Mercedes-Benz Service Contract** covers unforeseeable repairs, maintenance or wear parts, depending on the specific contract. Your local Mercedes-Benz dealer will be pleased to provide information about available Service Contracts and terms and conditions.

Mercedes-Benz Financial Services. Drive a Mercedes-Benz and remain flexible when it comes to payment: our attractive leasing and finance products make this possible – matched to your requirements and needs. We will also be happy to offer you a range of detailed insurance proposals. Just speak to your Mercedes-Benz dealer, who will be happy to provide information about our current range of financial services, terms and conditions.

¹ Alternatively: +49 69 95 30 72 77. Calls to a landline are chargeable. ² Calls from a mobile phone to a landline are chargeable. ³ When it expires, (four years after initial registration) Mobilo can be extended to up to 30 years from one service to the next by your authorised Mercedes-Benz service partner. ⁴ Mercedes-Benz service contract terms and conditions apply.

Enjoy the digital experience of Mercedes-Benz –

wherever you happen to be. Thanks to a range of offers optimised for smartphones and tablet computers, you can immerse yourself in the world of Mercedes-Benz even while on the move.

Insights into the full product range, a varied programme of entertainment and direct contact to a wide variety of services await you. Take an interactive tour with the **Interactive Owner's Manual**, for example, to get to know your dream car better. Experience the various functions in detail, take a close-up look at what's going on inside or explore the benefits of the particular model on your national Mercedes-Benz website.

With the **"Mercedes-Benz Guides"** app you can also explore the highlights of the various vehicles off-line. The app is available free of charge from the Apple® iTunes® Store (iOS) or the Google Play Store (Android).

Incidentally, our TV and magazine media are also available to watch and read digitally. Explore the whole brand world for yourself at www.mercedes-benz.com. Just click to take a look.

The **fascination of Mercedes-Benz**. A car whose name brings a gleam to the eyes of people all over the world, one that has featured in many a movie and been sung about in international hits, is surely far more than just a car. How did it come to this?

Discover just what has been moving the world for more than 125 years and take a fascinating journey through time as well as through the history of the automobile, in the **Mercedes-Benz Museum**. More than 1500 exhibits over a display area of 16500 square metres demonstrate the unique heritage and innovative power of the inventor of the automobile, among them one-off models such as the oldest Mercedes still in existence, built in 1902, or the legendary "Gullwing" cars. Welcome to a place of innovation: www.mercedes-benz-classic.com/museum

What would the history of Mercedes-Benz be like without **motorsport**? What would motorsport be without Mercedes-Benz? The first vehicle ever to win an automobile race was powered by a Daimler engine. The first Mercedes was a racing car. The Silver Arrows – a true legend. Out of this glorious past has grown an exciting present: the MERCEDES AMG PETRONAS Formula 1 team and the DTM Mercedes AMG C-Coupés fight it out weekend after weekend for points and victory.



Dimensions.

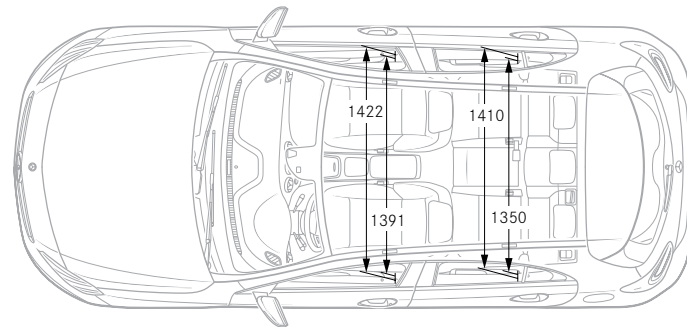
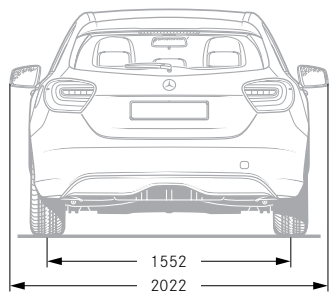
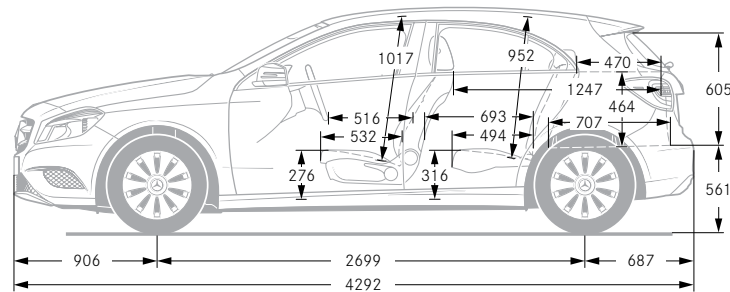
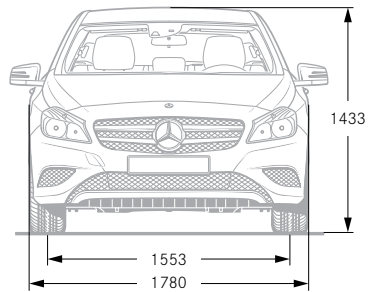

All dimensions in millimetres. The dimensions shown are mean values and apply to standard-specification, unladen vehicles.

Paintwork.

The paint system developed by Mercedes-Benz includes one of the best clear coats on the automotive market and is a key factor behind the car's excellent value retention. Its secret is the exceptionally thick molecular structure, which makes the metallic or non-metallic clear coat more resistant and produces a longer lasting and visibly more intensive shine.

Non-metallic paints

- 589 jupiter red
- 650 cirrus white
- 696 night black

Metallic paints¹

- 162 south seas blue
- 191 cosmos black
- 592 northern lights violet
- 761 polar silver
- 787 mountain grey
- 894 universe blue
- 990 orient brown

designo paint¹

- 662 designo mountain grey magno

For details of further individual designo paint finishes, please contact your Mercedes-Benz dealer.

¹ Optional extra.

Technical data.

	Diesel engines						
	A 160 CDI	A 180 CDI	A 180 CDI BlueEFFICIENCY Edition	A 200 CDI	A 200 CDI 4MATIC	A 220 CDI	A 220 CDI 4MATIC
No. of cylinders/arrangement	4/in-line	4/in-line	4/in-line	4/in-line	4/in-line	4/in-line	4/in-line
Total displacement in cc	1461	1461	1461	2143	2143	2143	2143
Rated output ¹ in kW (hp) at rpm	66 (90)/2750-4000	80 (109)/4000	80 (109)/4000	100 (136)/3200-4000	100 (136)/3200-4000	125 (170)/3400-4000	125 (170)/3400-4000
Rated torque ¹ in Nm at rpm	240/1700-2500	260/1750-2500	260/1750-2500	300/1400-3000	300/1400-3000	350/1400-3400	350/1400-3400
Transmission	6-speed manual [7G-DCT]	6-speed manual [7G-DCT]	6-speed manual	6-speed manual [7G-DCT]	- [7G-DCT]	- [7G-DCT]	- [7G-DCT]
Acceleration from 0-100 km/h in s [7G-DCT]	13.8 [14.1]	11.3 [11.6]	11.3	9.3 [9.2]	- [9.2]	- [8.2]	- [8.2]
Top speed, approx. in km/h	180	190	190	210	210	220	217
Tyre size, front	195/65 R 15	195/65 R 15	195/65 R 15	205/55 R 16	205/55 R 16	225/45 R 17	225/45 R 17
Tyre size, rear	195/65 R 15	195/65 R 15	195/65 R 15	205/55 R 16	205/55 R 16	225/45 R 17	225/45 R 17
Fuel	Diesel	Diesel	Diesel	Diesel	Diesel	Diesel	Diesel
Fuel consumption ² in l/100 km							
Urban [7G-DCT]	4.7-4.5 [5.0-4.6]	4.7-4.5 [5.0-4.6]	4.2-4.2	5.7-5.4 [4.9-4.7]	- [5.7-5.5]	- [5.0-4.8]	- [5.7-5.5]
Extra-urban [7G-DCT]	3.6-3.3 [3.8-3.6]	3.6-3.3 [3.8-3.6]	3.2-3.2	3.8-3.5 [3.7-3.5]	- [4.4-4.1]	- [3.7-3.5]	- [4.4-4.1]
Combined [7G-DCT]	4.0-3.8 [4.3-4.0]	4.0-3.8 [4.3-4.0]	3.6-3.6	4.5-4.2 [4.1-3.9]	- [4.9-4.6]	- [4.2-4.0]	- [4.9-4.6]
CO ₂ emissions ² in g/km combined [7G-DCT]	105-98 [111-103]	105-98 [111-103]	92-92	116-109 [108-102]	- [127-121]	- [109-104]	- [127-121]
Emission class ⁴	Euro 5	Euro 5	Euro 5	Euro 6	Euro 6	Euro 6	Euro 6
Efficiency class	A+	A+	A+	A	A	A+	A
Tank capacity in l/incl. approx. reserve	50/6.0	50/6.0	40/6.0	50/6.0	56/6.0	50/6.0	56/6.0
Boot capacity	341-1157	341-1157	341-1157	341-1157	341-1157	341-1157	341-1157
Turning circle diameter in m	11.00	11.00	11.00	11.00	11.00	11.00	11.00
Kerb weight/payload capacity ³ in kg [7G-DCT]	1395/565 [1425/535]	1395/565 [1425/535]	1385/465	1455/555 [1485/525]	- [1545/515]	- [1485/525]	- [1545/515]
Perm. GVW in kg [7G-DCT]	1960 [1960]	1960 [1960]	1850	2010 [2010]	- [2060]	- [2010]	- [2060]

Figures in square brackets apply to engines in conjunction with optional 7-speed dual clutch transmission 7G-DCT.

¹ Figures in accordance with Directive 80/1269/EEC in the currently applicable version. ² The figures shown were obtained in accordance with the prescribed measuring process (Regulation [EC] 715/2007 in the currently applicable version). The figures are not based on an individual vehicle and do not constitute part of the product offer; they are provided solely for purposes of comparison between different vehicle models.

Petrol engines

A 180	A 180 BlueEFFICIENCY Edition	A 200	A 250	A 250 4MATIC	A 250 Sport	A 250 Sport 4MATIC	A 45 AMG 4MATIC
4/in-line	4/in-line	4/in-line	4/in-line	4/in-line	4/in-line	4/in-line	4/in-line
1595	1595	1595	1991	1991	1991	1991	1991
90 (122)/5000	90 (122)/5000	115 (156)/5300	155 (211)/5500	155 (211)/5500	155 (211)/5500	155 (211)/5500	265 (360)/6000
200/1250-4000	200/1250-4000	250/1250-4000	350/1200-4000	350/1200-4000	350/1200-4000	350/1200-4000	450/2250-5000
6-speed manual [7G-DCT]	6-speed manual	6-speed manual [7G-DCT]	- [7G-DCT]	- [7G-DCT]	- [7G-DCT]	- [7G-DCT]	- [AMG SPEEDSHIFT DCT 7-speed sports transmission]
9.2 [9.1]	9.8	8.4 [8.3]	- [6.6]	- [6.5]	- [6.6]	- [6.5]	- [4.6]
202	190	224	240	240	240	240	250
195/65 R 15	195/65 R 15	205/55 R 16	225/45 R 17	225/45 R 17	235/40 R 18	235/40 R 18	235/40 R 18
195/65 R 15	195/65 R 15	205/55 R 16	225/45 R 17	225/45 R 17	235/40 R 18	235/40 R 18	235/40 R 18
Premium petrol	Premium petrol	Premium petrol	Premium petrol	Premium petrol	Premium petrol	Premium petrol	Super Plus petrol
7.7-7.5 [6.8-6.7]	6.9-6.9	7.7-7.5 [6.8-6.7]	- [8.1-8.0]	- [8.4-8.4]	- [7.9-7.9]	- [8.4-8.4]	- [9.1-8.8]
4.7-4.3 [4.6-4.2]	4.1-4.1	4.8-4.4 [4.6-4.2]	- [4.8-4.8]	- [5.5-5.4]	- [4.9-4.9]	- [5.6-5.6]	- [5.9-5.8]
5.8-5.5 [5.4-5.1]	5.2-5.2	5.8-5.5 [5.4-5.1]	- [6.0-5.9]	- [6.6-6.5]	- [6.0-6.0]	- [6.6-6.6]	- [7.1-6.9]
135-128 [126-119]	120-120	136-129 [126-119]	- [140-138]	- [154-152]	- [140-140]	- [154-154]	- [165-161]
Euro 6	Euro 6	Euro 6	Euro 6	Euro 6	Euro 6	Euro 6	Euro 6
B	B	B	C	C	C	C	D
50/6.0	40/6.0	50/6.0	50/6.0	56/6.0	50/6.0	56/6.0	56/8.0
341-1157	341-1157	341-1157	341-1157	341-1157	341-1157	341-1157	341-1157
11.00	11.00	11.00	11.00	11.00	11.00	11.00	11.04
1370/565 [1395/525]	1360/565	1370/565 [1395/525]	- [1445/525]	- [1505/525]	- [1465/505]	- [1505/525]	- [1555/495]
1935 [1920]	1925	1935 [1920]	- [1970]	- [2030]	- [1970]	- [2030]	- [2050]

³Figures according to Directive 92/21/EC, version 95/48/EC (kerb weight with fuel tank 90% full, driver, 68 kg, and luggage, 7 kg) for standard-specification vehicles. Optional extras and accessories will generally increase this figure and reduce the payload capacity accordingly. ⁴Figures only valid within the European Union. Further technical data can be found at www.mercedes-benz.com

Non-metallic paints

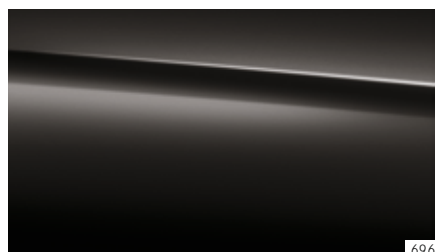

Metallic paints¹

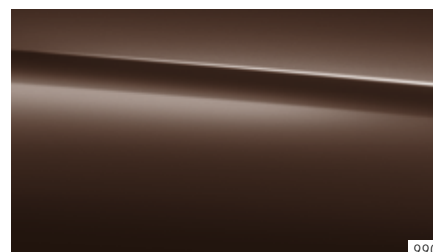
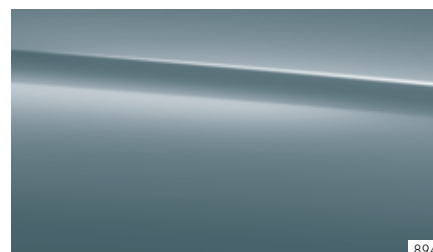
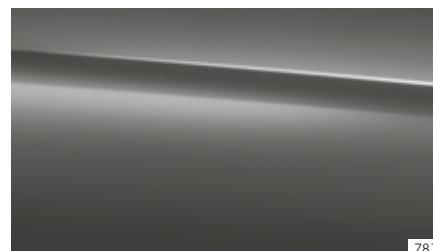
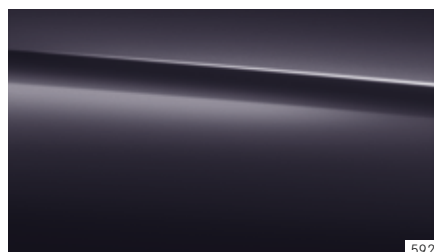
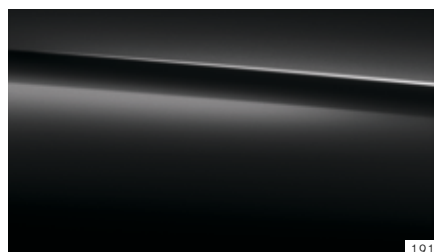

designo paint¹

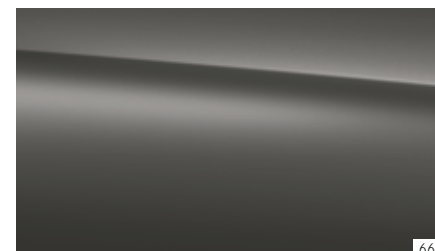

Take-back of end-of-life vehicles. We will be pleased to take back your A-Class for environment-friendly disposal in accordance with the EC End-Of-Life Vehicle Directive – but that day lies a long way off.

A network of vehicle take-back depots and dismantlers is available to make returning your vehicle as easy as possible for you. You are welcome to return your vehicle to one of these establishments free of charge. In so doing, you will be making a valuable contribution towards closing the recycling cycle and preserving resources.

For further information about the recycling and disposal of end-of-lifecycle vehicles, and the take-back conditions, please visit the national Mercedes-Benz website.

Please note: Changes may have been made to the product since going to print (27.01.2014). The manufacturer reserves the right during the delivery period to make changes to the design, form, colour or specification, provided these changes, while taking into account the interests of the vendor, can be deemed reasonable with respect to the purchaser. Where the vendor or the manufacturer uses symbols or numbers to describe an order or the subject of an order, no rights may be derived solely from these. The illustrations may include accessories and optional extras which do not form part of the standard specification. Colours may differ slightly from those shown, owing to the limitations of the printing process. This publication may include models and services which are not available in individual countries. Statements about legal and fiscal regulations and effects apply only to the Federal Republic of Germany. Please consult your nearest authorised Mercedes-Benz Passenger Car Dealer about the definitive latest version.

www.mercedes-benz.com